

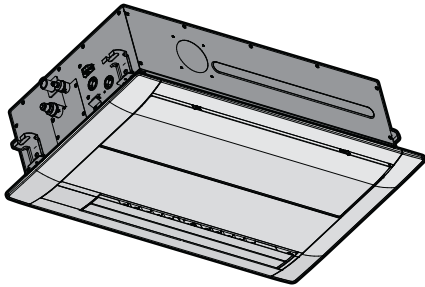

Installer and user reference guide
VRV system air conditioner



FXKA20AMVEB
FXKA25AMVEB
FXKA32AMVEB
FXKA40AMVEB
FXKA50AMVEB
FXKA63AMVEB

Table of contents

1	About the documentation	4
1.1	About this document.....	4
2	General safety precautions	6
2.1	About the documentation.....	6
2.1.1	Meaning of warnings and symbols.....	6
2.2	For the installer	7
2.2.1	General.....	7
2.2.2	Installation site.....	8
2.2.3	Refrigerant — in case of R410A or R32.....	8
2.2.4	Electrical.....	10
3	Specific installer safety instructions	13
3.1	Instructions for equipment using R32 refrigerant.....	15
3.1.1	Installation space requirements.....	16
For the user		17
4	User safety instructions	18
4.1	General.....	18
4.2	Instructions for safe operation	19
5	About the system	24
5.1	Components	24
5.2	Information requirements for fan coil units.....	25
6	User interface	26
7	Before operation	27
8	Operation	28
8.1	Operation range	28
8.2	About operation modes	28
8.2.1	Basic operation modes	28
8.2.2	Special heating operation modes.....	29
8.2.3	Adjusting the airflow direction.....	29
8.3	To operate the system	31
9	Energy saving and optimum operation	32
10	Maintenance and service	33
10.1	Precautions for maintenance and service	33
10.2	Cleaning the unit exterior and air filter	34
10.2.1	To clean the exterior.....	34
10.2.2	To clean the air filter.....	34
10.3	Maintenance before a long stop period	35
10.4	Maintenance after a long stop period	35
10.5	About the refrigerant	35
10.5.1	About the refrigerant leakage sensor	36
11	Troubleshooting	38
11.1	Symptoms that are NOT system malfunctions.....	39
11.1.1	Symptom: The system does not operate	39
11.1.2	Symptom: The fan speed does not correspond to the setting.....	39
11.1.3	Symptom: The fan direction does not correspond to the setting.....	39
11.1.4	Symptom: White mist comes out of a unit (Indoor unit).....	40
11.1.5	Symptom: White mist comes out of a unit (Indoor unit, outdoor unit).....	40
11.1.6	Symptom: The user interface reads "U4" or "U5" and stops, but then restarts after a few minutes.....	40
11.1.7	Symptom: Noise of air conditioners (Indoor unit)	40
11.1.8	Symptom: Noise of air conditioners (Indoor unit, outdoor unit)	40
11.1.9	Symptom: Dust comes out of the unit	40
11.1.10	Symptom: The units can give off odours.....	40
11.1.11	Symptom: The fan runs after the unit is turned off via the user interface	41
12	Relocation	42
13	Disposal	43

For the installer	44
14 About the box	45
14.1 Indoor unit.....	45
14.1.1 To unpack and handle the unit.....	45
14.1.2 To remove the accessories from the indoor unit.....	45
15 About the units and options	47
15.1 Identification	47
15.1.1 Identification label: Indoor unit.....	47
15.2 About the indoor unit.....	47
15.3 Components	47
15.4 Combining units and options	48
15.4.1 Possible options for the indoor unit.....	48
16 Unit installation	50
16.1 Preparing the installation site	50
16.1.1 Installation site requirements of the indoor unit.....	50
16.2 Mounting the indoor unit.....	52
16.2.1 Guidelines when installing the indoor unit	52
16.2.2 Guidelines when installing the drain piping	54
17 Piping installation	58
17.1 Preparing refrigerant piping.....	58
17.1.1 Refrigerant piping requirements.....	58
17.1.2 Refrigerant piping insulation	59
17.2 Connecting the refrigerant piping.....	59
17.2.1 About connecting the refrigerant piping	59
17.2.2 Precautions when connecting the refrigerant piping	60
17.2.3 Guidelines when connecting the refrigerant piping	61
17.2.4 Pipe bending guidelines.....	61
17.2.5 To flare the pipe end	61
17.2.6 To connect the refrigerant piping to the indoor unit	62
18 Electrical installation	64
18.1 About connecting the electrical wiring.....	64
18.1.1 Precautions when connecting the electrical wiring.....	64
18.1.2 Guidelines when connecting the electrical wiring	65
18.1.3 Specifications of standard wiring components.....	66
18.2 To connect the electrical wiring to the indoor unit.....	67
19 Commissioning	70
19.1 Overview: Commissioning.....	70
19.2 Precautions when commissioning	70
19.3 Checklist before commissioning	71
19.4 To perform a test run.....	71
20 Configuration	72
20.1 Field setting	72
21 Hand-over to the user	76
22 Troubleshooting	77
22.1 Solving problems based on error codes	77
22.1.1 Error codes: Overview	77
23 Disposal	79
24 Technical data	80
24.1 Wiring diagram	80
24.1.1 Unified wiring diagram legend	80
25 Glossary	83

1 About the documentation

1.1 About this document



WARNING

Make sure installation, servicing, maintenance, repair and applied materials follow the instructions from Daikin (including all documents listed in “Documentation set”) and, in addition, comply with applicable legislation and are performed by qualified persons only. In Europe and areas where IEC standards apply, EN/IEC 60335-2-40 is the applicable standard.

Target audience

Authorised installers + end users



INFORMATION

This appliance is intended to be used by expert or trained users in shops, in light industry and on farms, or for commercial use by lay persons.

Documentation set

This document is part of a documentation set. The complete set consists of:

- **General safety precautions:**
 - Safety instructions that you must read before installing
 - Format: Paper (in the box of the indoor unit)
- **Indoor unit installation and operation manual:**
 - Installation and operation instructions
 - Format: Paper (in the box of the indoor unit)
- **Installer and user reference guide:**
 - Preparation of the installation, good practices, reference data,...
 - Detailed step-by-step instructions and background information for basic and advanced usage
 - Format: Digital files on <https://www.daikin.eu>. Use the search function 🔍 to find your model.

The latest revision of the supplied documentation is published on the regional Daikin website and is available via your dealer.

Scan the QR code below to find the full documentation set and more information about your product on Daikin website.



The original instructions are written in English. All other languages are translations of the original instructions.

Technical engineering data

- A **subset** of the latest technical data is available on the regional Daikin website (publicly accessible).





- The **full set** of the latest technical data is available on the Daikin Business Portal (authentication required).

2 General safety precautions





2.1 About the documentation

- The original instructions are written in English. All other languages are translations of the original instructions.
- The precautions described in this document cover very important topics, follow them carefully.
- The installation of the system, and all activities described in the installation manual and in the installer reference guide **MUST** be performed by an authorised installer.



2.1.1 Meaning of warnings and symbols

	DANGER Indicates a situation that results in death or serious injury.
	DANGER: RISK OF ELECTROCUTION Indicates a situation that could result in electrocution.
	DANGER: RISK OF BURNING/SCALDING Indicates a situation that could result in burning/scalding because of extreme hot or cold temperatures.
	DANGER: RISK OF EXPLOSION Indicates a situation that could result in explosion.
	WARNING Indicates a situation that could result in death or serious injury.
	WARNING: FLAMMABLE MATERIAL
	A2L WARNING: MILDLY FLAMMABLE MATERIAL The refrigerant inside this unit is mildly flammable.
	CAUTION Indicates a situation that could result in minor or moderate injury.
	NOTICE Indicates a situation that could result in equipment or property damage.
	INFORMATION Indicates useful tips or additional information.

Symbols used on the unit:

Symbol	Explanation
	Before installation, read the installation and operation manual, and the wiring instruction sheet.
	Before performing maintenance and service tasks, read the service manual.
	For more information, see the installer and user reference guide.
	The unit contains rotating parts. Be careful when servicing or inspecting the unit.

Symbols used in the documentation:

Symbol	Explanation
	Indicates a figure title or a reference to it. Example: "▲ 1-3 Figure title" means "Figure 3 in chapter 1".
	Indicates a table title or a reference to it. Example: "■ 1-3 Table title" means "Table 3 in chapter 1".

2.2 For the installer

2.2.1 General

If you are NOT sure how to install or operate the unit, contact your dealer.



DANGER: RISK OF BURNING/SCALDING

- Do NOT touch the refrigerant piping, water piping or internal parts during and immediately after operation. It could be too hot or too cold. Give it time to return to normal temperature. If you MUST touch it, wear protective gloves.
- Do NOT touch any accidental leaking refrigerant.



WARNING

Improper installation or attachment of equipment or accessories could result in electrical shock, short-circuit, leaks, fire or other damage to the equipment. ONLY use accessories, optional equipment and spare parts made or approved by Daikin unless otherwise specified.



WARNING

Make sure installation, testing and applied materials comply with applicable legislation (on top of the instructions described in the Daikin documentation).



WARNING

Tear apart and throw away plastic packaging bags so that nobody, especially NOT children, can play with them. **Possible consequence:** suffocation.



WARNING

Provide adequate measures to prevent that the unit can be used as a shelter by small animals. Small animals that make contact with electrical parts can cause malfunctions, smoke or fire.



CAUTION

Wear adequate personal protective equipment (protective gloves, safety glasses,...) when installing, maintaining or servicing the system.



CAUTION

Do NOT touch the air inlet or aluminium fins of the unit.



CAUTION

- Do NOT place any objects or equipment on top of the unit.
- Do NOT sit, climb or stand on the unit.

In accordance with the applicable legislation, it might be necessary to provide a logbook with the product containing at least: information on maintenance, repair work, results of tests, stand-by periods,...

Also, at least, following information MUST be provided at an accessible place at the product:

- Instructions for shutting down the system in case of an emergency
- Name and address of fire department, police and hospital
- Name, address and day and night telephone numbers for obtaining service

In Europe, EN378 provides the necessary guidance for this logbook.

2.2.2 Installation site

- Provide sufficient space around the unit for servicing and air circulation.
- Make sure the installation site withstands the weight and vibration of the unit.
- Make sure the area is well ventilated. Do NOT block any ventilation openings.
- Make sure the unit is level.

Do NOT install the unit in the following places:

- In potentially explosive atmospheres.
- In places where there is machinery that emits electromagnetic waves. Electromagnetic waves may disturb the control system, and cause malfunction of the equipment.
- In places where there is a risk of fire due to the leakage of flammable gases (example: thinner or gasoline), carbon fibre, ignitable dust.
- In places where corrosive gas (example: sulphurous acid gas) is produced. Corrosion of copper pipes or soldered parts may cause the refrigerant to leak.

2.2.3 Refrigerant — in case of R410A or R32

If applicable. See the installation manual or installer reference guide of your application for more information.

**DANGER: RISK OF EXPLOSION**

Pump down – Refrigerant leakage. If you want to pump down the system, and there is a leak in the refrigerant circuit:

- Do NOT use the unit's automatic pump down function, with which you can collect all refrigerant from the system into the outdoor unit. **Possible consequence:** Self-combustion and explosion of the compressor because of air going into the operating compressor.
- Use a separate recovery system so that the unit's compressor does NOT have to operate.

**WARNING**

During tests, NEVER pressurise the product with a pressure higher than the maximum allowable pressure (as indicated on the nameplate of the unit).

**WARNING**

Take sufficient precautions in case of refrigerant leakage. If refrigerant gas leaks, ventilate the area immediately. Possible risks:

- Excessive refrigerant concentrations in a closed room can lead to oxygen deficiency.
- Toxic gas might be produced if refrigerant gas comes into contact with fire.

**WARNING**

ALWAYS recover the refrigerant. Do NOT release them directly into the environment. Use a vacuum pump to evacuate the installation.

**WARNING**

Make sure there is no oxygen in the system. Refrigerant may ONLY be charged after performing the leak test and the vacuum drying.

Possible consequence: Self-combustion and explosion of the compressor because of oxygen going into the operating compressor.

**NOTICE**

- To avoid compressor breakdown, do NOT charge more than the specified amount of refrigerant.
- When the refrigerant system is to be opened, refrigerant MUST be treated according to the applicable legislation.

**NOTICE**

Make sure refrigerant piping installation complies with applicable legislation. In Europe, EN378 is the applicable standard.

**NOTICE**



Make sure the field piping and connections are NOT subjected to stress.

**NOTICE**

After all the piping has been connected, make sure there is no gas leak. Use nitrogen to perform a gas leak detection.

- In case recharge is required, see the nameplate or the refrigerant charge label of the unit. It states the type of refrigerant and necessary amount.

- Whether the unit is factory charged with refrigerant or non-charged, in both cases you might need to charge additional refrigerant, depending on the pipe sizes and pipe lengths of the system.
- ONLY use tools exclusively for the refrigerant type used in the system, this to ensure pressure resistance and prevent foreign materials from entering into the system.
- Charge the liquid refrigerant as follows:

If	Then
A siphon tube is present (i.e., the cylinder is marked with "Liquid filling siphon attached")	Charge with the cylinder upright. 
A siphon tube is NOT present	Charge with the cylinder upside down. 

- Open refrigerant cylinders slowly.
- Charge the refrigerant in liquid form. Adding it in gas form may prevent normal operation.



CAUTION

When the refrigerant charging procedure is done or when pausing, close the valve of the refrigerant tank immediately. If the valve is NOT closed immediately, remaining pressure might charge additional refrigerant. **Possible consequence:** Incorrect refrigerant amount.

2.2.4 Electrical



DANGER: RISK OF ELECTROCUTION

- Turn OFF all power supply before removing the switch box cover, connecting electrical wiring or touching electrical parts.
- Disconnect the power supply for more than 10 minutes, and measure the voltage at the terminals of main circuit capacitors or electrical components before servicing. The voltage MUST be less than 50 V DC before you can touch electrical components. For the location of the terminals, see the wiring diagram.
- Do NOT touch electrical components with wet hands.
- Do NOT leave the unit unattended when the service cover is removed.



WARNING

If NOT factory installed, a main switch or other means for disconnection, having a contact separation in all poles providing full disconnection under overvoltage category III condition, MUST be installed in the fixed wiring.

**WARNING**

- ONLY use copper wires.
- Make sure the field wiring complies with the applicable legislation.
- All field wiring MUST be performed in accordance with the wiring diagram supplied with the product.
- NEVER squeeze bundled cables and make sure they do NOT come in contact with the piping and sharp edges. Make sure no external pressure is applied to the terminal connections.
- Make sure to install earth wiring. Do NOT earth the unit to a utility pipe, surge absorber, or telephone earth. Incomplete earth may cause electrical shock.
- Make sure to use a dedicated power circuit. NEVER use a power supply shared by another appliance.
- Make sure to install the required fuses or circuit breakers.
- Make sure to install an earth leakage protector. Failure to do so may cause electrical shock or fire.
- When installing the earth leakage protector, make sure it is compatible with the inverter (resistant to high frequency electric noise) to avoid unnecessary opening of the earth leakage protector.

**WARNING**

- After finishing the electrical work, confirm that each electrical component and terminal inside the switch box is connected securely.
- Make sure all covers are closed before starting up the unit.

**CAUTION**

- When connecting the power supply: connect the earth cable first, before making the current-carrying connections.
- When disconnecting the power supply: disconnect the current-carrying cables first, before separating the earth connection.
- The length of the conductors between the power supply stress relief and the terminal block itself MUST be as such that the current-carrying wires are tightened before the earth wire is in case the power supply is pulled loose from the stress relief.

**NOTICE**

Precautions when laying power wiring:



- Do NOT connect wiring of different thicknesses to the power terminal block (slack in the power wiring may cause abnormal heat).
- When connecting wiring which is the same thickness, do as shown in the figure above.
- For wiring, use the designated power wire and connect firmly, then secure to prevent outside pressure being exerted on the terminal board.
- Use an appropriate screwdriver for tightening the terminal screws. A screwdriver with a small head will damage the head and make proper tightening impossible.
- Over-tightening the terminal screws may break them.

Install power cables at least 1 meter away from televisions or radios to prevent interference. Depending on the radio waves, a distance of 1 meter may NOT be sufficient.

**NOTICE**

ONLY applicable if the power supply is three-phase, and the compressor has an ON/OFF starting method.

If there exists the possibility of reversed phase after a momentary black out and the power goes ON and OFF while the product is operating, attach a reversed phase protection circuit locally. Running the product in reversed phase can break the compressor and other parts.

3 Specific installer safety instructions

Always observe the following safety instructions and regulations.

General



WARNING

Make sure installation, servicing, maintenance, repair and applied materials follow the instructions from Daikin (including all documents listed in "Documentation set") and, in addition, comply with applicable legislation and are performed by qualified persons only. In Europe and areas where IEC standards apply, EN/IEC 60335-2-40 is the applicable standard.

Unit installation (see "16 Unit installation" [▶ 50])

For additional installation site requirements, read also "3.1 Instructions for equipment using R32 refrigerant" [▶ 15].



WARNING

The appliance shall be stored in a room without continuously operating ignition sources (example: open flames, an operating gas appliance or an operating electric heater).



CAUTION

Appliance NOT accessible to the general public, install it in a secured area, protected from easy access.

This unit, both indoor and outdoor, is suitable for installation in a commercial and light industrial environment.



WARNING

Keep any required ventilation openings clear of obstructions.

Refrigerant piping installation (see "17 Piping installation" [▶ 58])



CAUTION

Piping MUST be installed according to instructions given in "17 Piping installation" [▶ 58]. Only mechanical joints (e.g. braze+flare connections) that are compliant with the latest version of ISO14903 can be used.



CAUTION

- When **mechanical** connectors are re-used indoors, renew the sealing parts.
- When **flared joints** are re-used indoors, re-make the flared part.



CAUTION

Install the refrigerant piping or components in a position where they are unlikely to be exposed to any substance which may corrode components containing refrigerant, unless the components are constructed of materials that are inherently resistant to corrosion or are suitably protected against corrosion.

Electrical installation (see "18 Electrical installation" [▶ 64])



WARNING

ALWAYS use multicore cable for power supply cables.



WARNING

- All wiring **MUST** be performed by an authorised electrician and **MUST** comply with the national wiring regulation.
- Make electrical connections to the fixed wiring.
- All components procured on-site and all electrical construction **MUST** comply with the applicable legislation.



WARNING

- If the power supply has a missing or wrong N-phase, equipment might break down.
- Establish proper earthing. Do **NOT** earth the unit to a utility pipe, surge absorber, or telephone earth. Incomplete earthing may cause electrical shocks.
- Install the required fuses or circuit breakers.
- Secure the electrical wiring with cable ties so that the cables do **NOT** come in contact with sharp edges or piping, particularly on the high-pressure side.
- Do **NOT** use taped wires, extension cords, or connections from a star system. They can cause overheating, electrical shocks or fire.
- Do **NOT** install a phase advancing capacitor, because this unit is equipped with an inverter. A phase advancing capacitor will reduce performance and may cause accidents.



WARNING

If **NOT** factory installed, a main switch or other means for disconnection, having a contact separation in all poles providing full disconnection under overvoltage category III condition, **MUST** be installed in the fixed wiring.



WARNING

If the supply cord is damaged, it **MUST** be replaced by the manufacturer, its service agent or similarly qualified persons in order to avoid a hazard.



CAUTION

- Each indoor unit has to be connected to a separate user interface. Only a safety system compatible remote controller can be used as the user interface. See technical data sheet for remote controller compatibility (e.g. BRC1H52/82*).
- The user interface has to be put in the same room as the indoor unit. For details, please refer to the installation and operation manual of the user interface.



CAUTION

In case shielded wire is used, connect the shielding to the outdoor unit side only.

Configuration (see "20 Configuration" [▶ 72])



WARNING

In case of R32 refrigerant, terminal connections T1/T2 are for fire alarm input **ONLY**. Fire alarm has a higher priority than R32 safety and shuts the entire system down.



a Fire alarm input signal (potential free contact)

3.1 Instructions for equipment using R32 refrigerant



A2L

WARNING: MILDLY FLAMMABLE MATERIAL

The refrigerant inside this unit is mildly flammable.

**WARNING**

- Do NOT pierce or burn refrigerant cycle parts.
- Do NOT use cleaning materials or means to accelerate the defrosting process other than those recommended by the manufacturer.
- Be aware that the refrigerant inside the system is odourless.

**WARNING**

The appliance shall be stored so as to prevent mechanical damage and in a well-ventilated room without continuously operating ignition sources (example: open flames, an operating gas appliance or an operating electric heater) and have a room size as specified below.

**WARNING**

Make sure installation, servicing, maintenance and repair comply with instructions from Daikin and with applicable legislation (for example national gas regulation) and are executed ONLY by authorised persons.

**WARNING**

- Take precautions to avoid excessive vibration or pulsation to refrigeration piping.
- Protect the protection devices, piping and fittings as much as possible against adverse environmental effects.
- Provide space for expansion and contraction of long runs of piping.
- Design and install piping in refrigerating systems such as to minimise the likelihood of hydraulic shock damaging the system.
- Mount the indoor equipment and pipes securely and protect them to avoid accidental rupture of equipment or pipes in case of events such as moving furniture or reconstruction activities.

**CAUTION**

- Incomplete flaring may cause refrigerant gas leakage.
- Do NOT re-use flares. Use new flares to prevent refrigerant gas leakage.
- Use flare nuts that are included with the unit. Using different flare nuts may cause refrigerant gas leakage.

**CAUTION**

Do NOT use potential sources of ignition in searching for or detection of refrigerant leaks.

**NOTICE**

- Do NOT re-use joints and copper gaskets which have been used already.
- Joints made in the installation between parts of the refrigerant system shall be accessible for maintenance purposes.



CAUTION

Field-made refrigerant joints indoors shall be tightness tested. The test method shall have a sensitivity of 5 grams per year of refrigerant or better under a pressure of at least 0,25 times the maximum allowable pressure. No leak shall be detected.

3.1.1 Installation space requirements



CAUTION

The total refrigerant charge and/or releasable charge m_{rl} in the system cannot exceed the requirements for minimum floor area of the smallest room that is served. For minimum floor area requirements for indoor units, see the installation and operation manual of the outdoor unit.



NOTICE

- The pipework shall be securely mounted and guarded protected from physical damage.
- Keep the pipework installation to a minimum.

For the user

4 User safety instructions

Always observe the following safety instructions and regulations.

4.1 General



WARNING

If you are NOT sure how to operate the unit, contact your installer.



WARNING

This appliance can be used by children aged from 8 years and above and persons with reduced physical, sensory or mental capabilities or lack of experience and knowledge if they have been given supervision or instruction concerning use of the appliance in a safe way and understand the hazards involved.

Children SHALL NOT play with the appliance.

Cleaning and user maintenance SHALL NOT be made by children without supervision.



WARNING

To prevent electrical shocks or fire:

- Do NOT rinse the unit.
- Do NOT operate the unit with wet hands.
- Do NOT place any objects containing water on the unit.



CAUTION

- Do NOT place any objects or equipment on top of the unit.
- Do NOT sit, climb or stand on the unit.

- Units are marked with the following symbol:



This means that electrical and electronic products may NOT be mixed with unsorted household waste. Do NOT try to dismantle the system yourself: dismantling the system, treatment of the refrigerant, of oil and of other parts MUST be done by an authorised installer and MUST comply with applicable legislation.

Units MUST be treated at a specialised treatment facility for reuse, recycling and recovery. By ensuring this product is disposed of correctly, you will help to prevent potential negative consequences for the environment and human health. For more information, contact your installer or local authority.

- Batteries are marked with the following symbol:



This means that the batteries may NOT be mixed with unsorted household waste. If a chemical symbol is printed beneath the symbol, this chemical symbol means that the battery contains a heavy metal above a certain concentration.

Possible chemical symbols are: Pb: lead (>0.004%).

Waste batteries MUST be treated at a specialised treatment facility for reuse. By ensuring waste batteries are disposed of correctly, you will help to prevent potential negative consequences for the environment and human health.

4.2 Instructions for safe operation



WARNING

- Do NOT modify, disassemble, remove, reinstall or repair the unit yourself as incorrect dismantling or installation may cause an electrical shock or fire. Contact your dealer.
- In case of accidental refrigerant leaks, make sure there are no naked flames. The refrigerant itself is entirely safe, non-toxic and mildly flammable, but it will generate toxic gas when it accidentally leaks into a room where combustible air from fan heaters, gas cookers, etc. is present. Always have qualified service personnel confirm that the point of leakage has been repaired or corrected before resuming operation.



CAUTION

This unit is equipped with a leak detection system for safety. To be effective, the unit must be electrically powered at all times after installation, other than when servicing.



CAUTION

- NEVER touch the internal parts of the controller.
- Do NOT remove the front panel. Some parts inside are dangerous to touch and appliance problems may happen. For checking and adjusting the internal parts, contact your dealer.



WARNING

This unit contains electrical and hot parts.



WARNING

Before operating the unit, be sure the installation has been carried out correctly by an installer.



CAUTION

It is unhealthy to expose your body to the air flow for a long time.



CAUTION

To avoid oxygen deficiency, ventilate the room sufficiently if equipment with burner is used together with the system.



CAUTION

Do NOT operate the system when using a room fumigation-type insecticide. Chemicals could collect in the unit, and endanger the health of people who are hypersensitive to chemicals.



CAUTION

ALWAYS use the user interface to adjust the position of the flaps and louvers. When the flaps and louvers are swinging and you move them forcibly by hand, the mechanism will break.



WARNING

NEVER touch the air outlet or the horizontal/vertical blades while the swing flap is in operation. Fingers may become caught or the unit may break down.



CAUTION

NEVER expose little children, plants or animals directly to the airflow.

**WARNING**

Do NOT place a flammable spray bottle near the air conditioner and do NOT use sprays near the unit. Doing so may result in a fire.

**WARNING**

Keep any required ventilation openings clear of obstructions.

**WARNING**

If the supply cord is damaged, it MUST be replaced by the manufacturer, its service agent or similarly qualified persons in order to avoid a hazard.

Maintenance and service (see "10 Maintenance and service" [▶ 33])**CAUTION: Pay attention to the fan!**

It is dangerous to inspect the unit while the fan is running. Make sure to turn OFF the main switch before executing any maintenance task.

**CAUTION**

Do NOT insert fingers, rods or other objects into the air inlet or outlet. When the fan is rotating at high speed, it will cause injury.

**WARNING**

NEVER replace a fuse with a fuse of a wrong ampere ratings or other wires when a fuse blows out. Use of wire or copper wire may cause the unit to break down or cause a fire.

**CAUTION**

After a long use, check the unit stand and fitting for damage. If damaged, the unit may fall and result in injury.

**CAUTION**

Before accessing terminal devices, make sure to interrupt all power supply.



DANGER: RISK OF ELECTROCUTION

To clean the air conditioner or air filter, be sure to stop operation and turn all power supplies OFF. Otherwise, an electrical shock and injury may result.



WARNING

Be careful with ladders when working in high places.



DANGER: RISK OF ELECTROCUTION

Disconnect the power supply for more than 10 minutes, and measure the voltage at the terminals of main circuit capacitors or electrical components before servicing. The voltage **MUST** be less than 50 V DC before you can touch electrical components. For the location of the terminals, see the warning label for persons performing service and maintenance.



CAUTION

Turn off the unit before cleaning the unit exterior and air filter.



WARNING

Do NOT let the indoor unit get wet. **Possible consequence:** Electrical shock or fire.

[About the refrigerant \(see "10.5 About the refrigerant" \[▶ 35\]\)](#)



A2L

WARNING: MILDLY FLAMMABLE MATERIAL

The refrigerant inside this unit is mildly flammable.



WARNING

The appliance shall be stored in a room without continuously operating ignition sources (example: open flames, an operating gas appliance or an operating electric heater).

**WARNING**

- Do NOT pierce or burn refrigerant cycle parts.
- Do NOT use cleaning materials or means to accelerate the defrosting process other than those recommended by the manufacturer.
- Be aware that the refrigerant inside the system is odourless.

**WARNING**

- The refrigerant inside the unit is mildly flammable, but normally does NOT leak. If the refrigerant leaks in the room and comes in contact with fire from a burner, a heater, or a cooker, this may result in fire, or the formation of a harmful gas.
- Turn OFF any combustible heating devices, ventilate the room, and contact the dealer where you purchased the unit.
- Do NOT use the unit until a service person confirms that the part from which the refrigerant leaked has been repaired.

**WARNING**

The R32 refrigerant leakage sensor must be replaced after every detection or at the end of its lifetime. ONLY authorised persons may replace the sensor.

**CAUTION**

When replacing the R32 refrigerant leakage sensor, replace it with the sensor specified by the manufacturer (refer to the spare parts list).

Troubleshooting (see "11 Troubleshooting" [▶ 38])

**WARNING**

Stop operation and shut OFF the power if anything unusual occurs (burning smells etc.).

Leaving the unit running under such circumstances may cause breakage, electrical shock or fire. Contact your dealer.

5 About the system



WARNING

- Do NOT modify, disassemble, remove, reinstall or repair the unit yourself as incorrect dismantling or installation may cause an electrical shock or fire. Contact your dealer.
- In case of accidental refrigerant leaks, make sure there are no naked flames. The refrigerant itself is entirely safe, non-toxic and mildly flammable, but it will generate toxic gas when it accidentally leaks into a room where combustible air from fan heaters, gas cookers, etc. is present. Always have qualified service personnel confirm that the point of leakage has been repaired or corrected before resuming operation.



WARNING

The unit is equipped with a refrigerant leak detection system for safety.

To be effective, the unit MUST be electrically powered at all times after installation, except for short service periods.



NOTICE

Do NOT use the system for other purposes. In order to avoid any quality deterioration, do NOT use the unit for cooling precision instruments, food, plants, animals, or works of art.



NOTICE

For future modifications or expansions of your system:

A full overview of allowable combinations (for future system extensions) is available in technical engineering data and should be consulted. Contact your installer to receive more information and professional advice.

5.1 Components



INFORMATION

The following figure is an example and may NOT completely match your system layout

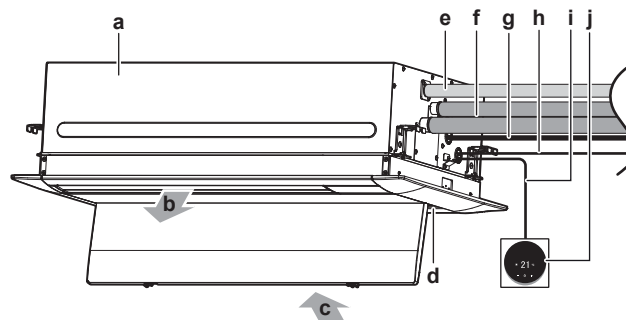

- a Indoor unit
- b Discharge air
- c Suction air
- d Air filter
- e Drain pipe
- f Refrigerant piping
- g Power supply cable
- h Interconnection cable
- i Interconnection cable
- j Interconnection cable

- i User interface cable
j User interface

5.2 Information requirements for fan coil units

Item	Symbol	Value	Unit
Cooling capacity (sensible)	$P_{\text{rated,c}}$	A	kW
Cooling capacity (latent)	$P_{\text{rated,c}}$	B	kW
Heating capacity	$P_{\text{rated,h}}$	C	kW
Total electric power input	P_{elec}	D	kW
Sound power level (cooling, per speed setting if applicable) H: High, M: Medium, L: Low	L_{WA}	E	dB(A)
Sound power level (heating, per speed setting if applicable) H: High, M: Medium, L: Low	L_{WA}	F	dB(A)
Contact details: DAIKIN INDUSTRIES CZECH REPUBLIC s.r.o. U Nové Hospody 1155/1, 301 00 Plzeň Skvrňany, Czech Republic			

	A	B	C	D	E	F
FXKA20AMVEB	1.5	0.7	2.5	0.034	H: 46.0, M: 43.5, L: 41.0	H: 50.0, M: 46.0, L: 41.5
FXKA25AMVEB	1.9	0.9	3.2	0.034	H: 46.0, M: 43.5, L: 41.0	H: 50.0, M: 46.0, L: 41.5
FXKA32AMVEB	2.4	1.2	4	0.039	H: 50.5, M: 48.5, L: 46.5	H: 52.5, M: 49.5, L: 47.0
FXKA40AMVEB	3	1.5	5	0.047	H: 52.5, M: 50.0, L: 48.0	H: 53.0, M: 50.5, L: 48.0
FXKA50AMVEB	3.7	1.9	6.3	0.073	H: 57.0, M: 52.5, L: 50.0	H: 58.0, M: 53.0, L: 50.5
FXKA63AMVEB	4.8	2.3	8	0.118	H: 61.5, M: 57.0, L: 52.5	H: 63.5, M: 58.0, L: 53.0

6 User interface



CAUTION

- NEVER touch the internal parts of the controller.
- Do NOT remove the front panel. Some parts inside are dangerous to touch and appliance problems may happen. For checking and adjusting the internal parts, contact your dealer.



NOTICE

Do NOT wipe the controller operation panel with benzine, thinner, chemical dust cloth, etc. The panel may get discoloured or the coating peeled off. If it is heavily dirty, soak a cloth in water-diluted neutral detergent, squeeze it well and wipe the panel clean. Wipe it with another dry cloth.



NOTICE

NEVER press the button of the user interface with a hard, pointed object. The user interface may be damaged.



NOTICE

NEVER pull or twist the electric wire of the user interface. It may cause the unit to malfunction.

This operation manual offers a non-exhaustive overview of the main functions of the system.

For more information about the user interface, see the operation manual of the installed user interface.

7 Before operation

**CAUTION**

See "[4 User safety instructions](#)" [▶ 18] to acknowledge all related safety instructions.

This operation manual is for the following systems with standard control. Before initiating operation, contact your dealer for the operation that corresponds to your system type and mark. If your installation has a customised control system, ask your dealer for the operation that corresponds to your system.

8 Operation

8.1 Operation range



INFORMATION

For the operation limits see the technical data of the connected outdoor unit.

8.2 About operation modes



INFORMATION

Depending on the installed system, some operation modes will not be available.



- The air flow rate may adjust itself depending on the room temperature or the fan may stop immediately. This is not a malfunction.
- If the main power supply is turned off during operation, operation will restart automatically after the power turns back on again.
- **Setpoint.** Target temperature for the Cooling, Heating, and Auto operation modes.
- **Setback.** A function that keeps the room temperature in a specific range when the system is turned off (by the user, the schedule function, or the OFF timer).

8.2.1 Basic operation modes

The indoor unit can operate in various operation modes.

Icon	Operation mode
	Cooling. In this mode, cooling will be activated as required by the setpoint, or by Setback operation.
	Heating. In this mode, heating will be activated as required by the setpoint, or by Setback operation.
	Fan only. In this mode, air circulates without heating or cooling.
	Dry. In this mode, the air humidity will be lowered with a minimal temperature decrease. The temperature and fan speed are controlled automatically and cannot be controlled by the controller. Dry operation will not function if the room temperature is too low.
	Auto. In Auto mode, the indoor unit automatically switches between heating and cooling mode, as required by the setpoint.

8.2.2 Special heating operation modes

Operation	Description
Defrost	<p>To prevent a loss of heating capacity due to frost accumulation in the outdoor unit, the system will automatically switch to defrost operation.</p> <p>During defrost operation, the indoor unit fan will stop operation, and the following icon will appear on the home screen:</p>  <p>The system will resume normal operation after approximately 6 to 8 minutes.</p>
Hot start	<p>During hot start, the indoor unit fan will stop operation, and the following icon will appear on the home screen:</p> 

8.2.3 Adjusting the airflow direction

When. Adjust the airflow direction as desired.

What. The system directs the airflow differently, depending on the user selection.

**CAUTION**



ALWAYS use the user interface to adjust the position of the flaps and louvers. When the flaps and louvers are swinging and you move them forcibly by hand, the mechanism will break.

**INFORMATION**

For setting procedure of the airflow direction, see the reference guide or the manual of the used user interface.

1 Vertical airflow

The following vertical airflow directions can be set by the user interface:

Direction	Display
Fixed position. The indoor unit blows air in 1 of 5 fixed positions.	
Swing. The indoor unit alternates between the 5 positions.	

Note: Recommended position of the horizontal blades (flaps) varies according to the operation mode.

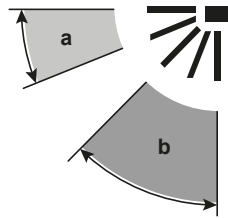

- a Cooling operation
- b Heating operation

2 Horizontal airflow

The following horizontal airflow directions can be set by the user interface:

Direction	Display
Fixed position. The indoor unit blows air in 1 of 5 fixed positions.	
Swing. The indoor unit alternates between the 5 positions.	



INFORMATION

When the unit is installed in a corner of a room, the direction of the louvers should be facing away from the wall. Efficiency will drop if a wall blocks the air.

Automatic airflow control

Cooling	Heating
<ul style="list-style-type: none"> ▪ When the room temperature is lower than the controller's setpoint for cooling operation (including auto operation). ▪ When the indoor units run in Continuous operation, and the airflow direction is downward. 	<ul style="list-style-type: none"> ▪ When starting operation. ▪ When the room temperature is higher than the controller's setpoint for heating operation (including auto operation). ▪ At defrost operation.
<ul style="list-style-type: none"> ▪ When the indoor units run continuously for a long time and the airflow direction is Horizontal. 	



WARNING

NEVER touch the air outlet or the horizontal/vertical blades while the swing flap is in operation. Fingers may become caught or the unit may break down.



NOTICE

Avoid operating in the horizontal direction. It may cause dew or dust to settle on the ceiling or flap.

8.3 To operate the system



INFORMATION

For setting of the operation mode, airflow direction or other settings, see the reference guide or operation manual of the user interface.

9 Energy saving and optimum operation



CAUTION

NEVER expose little children, plants or animals directly to the airflow.



NOTICE

Do NOT place objects below the indoor and/or outdoor unit that may get wet. Otherwise condensation on the unit or refrigerant pipes, air filter dirt or drain blockage may cause dripping, and objects under the unit may get dirty or damaged.



WARNING

Do NOT place a flammable spray bottle near the air conditioner and do NOT use sprays near the unit. Doing so may result in a fire.



WARNING

Keep any required ventilation openings clear of obstructions.

Observe the following precautions to ensure the system operates properly.

- Prevent direct sunlight from entering a room during cooling operation by using curtains or blinds.
- Make sure the area is well ventilated. Do NOT block any ventilation openings.
- Ventilate often. Extended use requires special attention to ventilation.
- Keep doors and windows closed. If the doors and windows remain open, air will flow out of your room causing a decrease in the cooling or heating effect.
- Be careful NOT to cool or heat too much. To save energy, keep the temperature setting at a moderate level.
- NEVER place objects near the air inlet or the air outlet of the unit. Doing so may cause a reduced heating/cooling effect or stop operation.
- When the display shows  (time to clean the air filter), clean the filters (see "10.2.2 To clean the air filter" [▶ 34]).
- Condensation may form if the humidity is above 80% or if the drain outlet gets blocked.
- Adjust the air outlet properly and avoid direct air flow to room inhabitants.

10 Maintenance and service

10.1 Precautions for maintenance and service



CAUTION

See "4 User safety instructions" [▶ 18] to acknowledge all related safety instructions.



NOTICE

NEVER inspect or service the unit by yourself. Ask a qualified service person to perform this work. However, as end user, you may clean the air filter and the unit exterior.



NOTICE

Maintenance MUST be done by an authorised installer or service agent.

We recommend performing maintenance at least once a year. However, applicable legislation might require shorter maintenance intervals.



NOTICE

Do NOT wipe the controller operation panel with benzene, thinner, chemical dust cloth, etc. The panel may get discoloured or the coating peeled off. If it is heavily dirty, soak a cloth in water-diluted neutral detergent, squeeze it well and wipe the panel clean. Wipe it with another dry cloth.

Following symbols may occur on the indoor unit:

Symbol	Explanation
	Measure the voltage at the terminals of main circuit capacitors or electrical components before servicing.



NOTICE

When cleaning the heat exchanger, make sure to remove the electronic components above it. Water or detergent might deteriorate the insulation of electronic components and result in burnout of these components.



DANGER: RISK OF ELECTROCUTION

Disconnect the power supply for more than 10 minutes, and measure the voltage at the terminals of main circuit capacitors or electrical components before servicing. The voltage MUST be less than 50 V DC before you can touch electrical components. For the location of the terminals, see the warning label for persons performing service and maintenance.

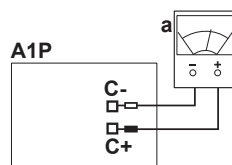

- A1P** Main printed circuit board
- a** Multimeter
- C** Residual voltage measuring points

10.2 Cleaning the unit exterior and air filter



CAUTION

Turn off the unit before cleaning the unit exterior and air filter.



NOTICE

- Do NOT use gasoline, benzene, thinner polishing powder or liquid insecticide. **Possible consequence:** Discoloration and deformation.
- Do NOT use water or air of 50°C or higher. **Possible consequence:** Discoloration and deformation.
- Do NOT scrub firmly when washing the blade with water. **Possible consequence:** The surface sealing peels off.

10.2.1 To clean the exterior



WARNING

Do NOT let the indoor unit get wet. **Possible consequence:** Electrical shock or fire.

Clean with a soft cloth. If it is difficult to remove stains, use water or neutral detergent and wipe with a dry cloth.

10.2.2 To clean the air filter

When to clean the air filter:

- Rule of thumb: Clean every 6 months. If the air in the room is extremely contaminated, increase the cleaning frequency.
- Depending on the settings, the user interface can display the **"Time to clean filter"** notification. Clean the air filter when the notification is displayed.
- If the dirt becomes impossible to clean, change the air filter (= optional equipment).

How to clean the air filter:

- 1 **Open the panel.** Simultaneously slide the two knobs and open the decoration panel carefully.

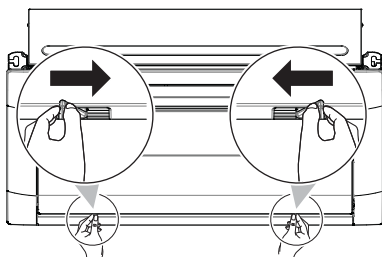

- 2 **Remove the air filters.** Holding the filter knob unhook the filter from the unit (2 places on each filter) and remove the filter.

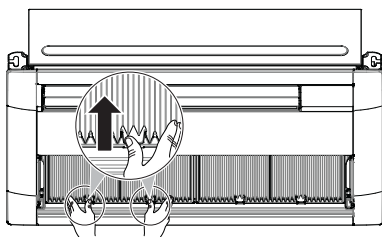

- 3 Clean the air filters.** Use a vacuum cleaner or wash with water. If the air filter is very dirty, use a soft brush and neutral detergent.

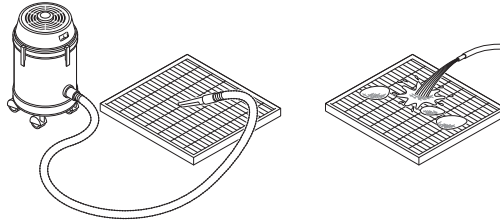

- 4** Dry the air filters in the shadow.
5 Reattach the air filters and close panel.
6 Turn ON the power.
7 To remove warning screens, see the reference guide of the user interface.

10.3 Maintenance before a long stop period

E.g., at the end of the season.

- Let the indoor units run in fan only operation for about half a day in order to dry the interior of the units.
- Clean air filters and casings of indoor units (see ["10.2 Cleaning the unit exterior and air filter"](#) [▶ 34]).
- Remove the batteries from the user interface (if applicable).

10.4 Maintenance after a long stop period

E.g., at the beginning of the season.

- Check and remove everything that might be blocking inlet and outlet vents of indoor units and outdoor units.
- Clean air filters and casings of indoor units (see ["10.2 Cleaning the unit exterior and air filter"](#) [▶ 34]).
- Insert batteries in the user interface (if applicable).

10.5 About the refrigerant

This product contains fluorinated greenhouse gases. Do NOT vent gases into the atmosphere.

Refrigerant type: R32

Global warming potential (GWP) value: 675

Periodical inspections for refrigerant leaks may be required depending on the applicable legislation. Contact your installer for more information.



A2L

WARNING: MILDLY FLAMMABLE MATERIAL

The refrigerant inside this unit is mildly flammable.



WARNING

- The refrigerant inside the unit is mildly flammable, but normally does NOT leak. If the refrigerant leaks in the room and comes in contact with fire from a burner, a heater, or a cooker, this may result in fire, or the formation of a harmful gas.
- Turn OFF any combustible heating devices, ventilate the room, and contact the dealer where you purchased the unit.
- Do NOT use the unit until a service person confirms that the part from which the refrigerant leaked has been repaired.



WARNING

The appliance shall be stored in a room without continuously operating ignition sources (example: open flames, an operating gas appliance or an operating electric heater).



WARNING

- Do NOT pierce or burn refrigerant cycle parts.
- Do NOT use cleaning materials or means to accelerate the defrosting process other than those recommended by the manufacturer.
- Be aware that the refrigerant inside the system is odourless.



NOTICE

Applicable legislation on **fluorinated greenhouse gases** requires that the refrigerant charge of the unit is indicated both in weight and CO₂ equivalent.

Formula to calculate the quantity in CO₂ equivalent tonnes: GWP value of the refrigerant × total refrigerant charge [in kg]/1000

Contact your installer for more information.

10.5.1 About the refrigerant leakage sensor



WARNING

The R32 refrigerant leakage sensor must be replaced after every detection or at the end of its lifetime. ONLY authorised persons may replace the sensor.



NOTICE

The R32 refrigerant leakage sensor is a semiconductor detector which may incorrectly detect substances other than R32 refrigerant. Avoid using chemical substances (e.g. organic solvents, hair spray, paint) in high concentrations, in the close proximity of the indoor unit because this may cause misdetection by the R32 refrigerant leakage sensor.



NOTICE

Functionality of the safety measures are periodically automatically checked. In case of malfunction, an error code will be displayed on the user interface.



INFORMATION

The sensor has a lifetime of 10 years. The user interface displays error "**CH-05**" 6 months before the end of the sensor lifetime and error "**CH-02**" after the end of the sensor lifetime. For more information, refer to the reference guide of the user interface and contact your dealer.

**CAUTION**

When replacing the R32 refrigerant leakage sensor, replace it with the sensor specified by the manufacturer (refer to the spare parts list).

In case of detection when the unit is operating

- 1 The user interface displays error "**A0-11**" and emits an alarm sound. The status indicator blinks.
- 2 Contact your dealer immediately. For more information, see the installation manual of the outdoor unit.

In case of detection when the unit is in standby

When the detection occurs when the unit is in standby, the unit performs a "false detection check".

False detection check

- 1 The fan starts turning on the lowest setting.
- 2 The user interface displays error "**A0-13**" and emits an alarm sound. The status indicator blinks.
- 3 The sensor checks if a refrigerant leakage or misdetection occurred.
 - No refrigerant leakage detected. **Result:** The system resumes normal operation after approximately 2 minutes.
 - Refrigerant leakage detected. **Result:**
 - 1 The user interface displays error "**A0-11**" and emits an alarm sound. The status indicator blinks.
 - 2 Contact your dealer immediately. For more information, see the installation manual of the outdoor unit.

**INFORMATION**

The minimum airflow during normal operation or during the refrigerant leakage detection is always $>240 \text{ m}^3/\text{h}$.

**INFORMATION**

To stop the alarm of the user interface, see the reference guide of the user interface.

11 Troubleshooting

If one of the following malfunctions occurs, take the measures shown below and contact your dealer.



WARNING

Stop operation and shut OFF the power if anything unusual occurs (burning smells etc.).

Leaving the unit running under such circumstances may cause breakage, electrical shock or fire. Contact your dealer.

The system **MUST** be repaired by a qualified service person.

Malfunction	Measure
If a safety device such as a fuse, a circuit breaker or a residual current device frequently actuates or the ON/OFF switch does NOT function properly.	Turn OFF all main power supply switches to the unit.
If water leaks from the unit.	Stop operation.
The operation switch does NOT function properly.	Turn OFF the power supply.
If the user interface displays  .	Notify your installer and report the error code. To display an error code see the reference guide of the user interface.

If the system does NOT operate properly except for the above mentioned cases and none of the above mentioned malfunctions is evident, investigate the system in accordance with the following procedures.

Malfunction	Measure
If the system does not operate at all.	<ul style="list-style-type: none"> ▪ Check if there is no power failure. Wait until power is restored. If power failure occurs during operation, the system automatically restarts immediately after power is restored. ▪ Check if no fuse has blown or breaker is activated. Change the fuse or reset the breaker if necessary.

Malfunction	Measure
The system operates but cooling or heating is insufficient.	<ul style="list-style-type: none"> ▪ Check if air inlet or outlet of outdoor or indoor unit is not blocked by obstacles. Remove any obstacles and make sure the air can flow freely. ▪ Check if the air filter is not clogged (see "10.2.2 To clean the air filter" [▶ 34]). ▪ Check the temperature setting. ▪ Check the fan speed setting on your user interface. ▪ Check for open doors or windows. Close doors and windows to prevent wind from coming in. ▪ Check if there are too many occupants in the room during cooling operation. Check if the heat source of the room is excessive. ▪ Check if direct sunlight enters the room. Use curtains or blinds. ▪ Check if the air flow angle is proper.

If after checking all above items, it is impossible to fix the problem yourself, contact your installer and state the symptoms, the complete model name of the unit (with manufacturing number if possible) and the installation date (possibly listed on the warranty card).

11.1 Symptoms that are NOT system malfunctions

The following symptoms are NOT system malfunctions:

11.1.1 Symptom: The system does not operate

- The air conditioner does not start immediately after the ON/OFF button on the user interface is pressed. If the operation lamp lights, the system is in normal condition. To prevent overloading of the compressor motor, the air conditioner starts 5 minutes after it is turned ON again in case it was turned OFF just before. The same starting delay occurs after the operation mode selector button was used.
- The system does not start immediately after the power supply is turned on. Wait one minute until the micro computer is prepared for operation.

11.1.2 Symptom: The fan speed does not correspond to the setting

The fan speed does not change even if the fan speed adjustment button is pressed. During heating operation, when the room temperature reaches the set temperature, the outdoor unit goes off and the indoor unit changes to whisper fan speed. This is to prevent cold air blowing directly on occupants of the room. The fan speed will not change if the button is pressed.

11.1.3 Symptom: The fan direction does not correspond to the setting

The fan direction does not correspond with the user interface display. The fan direction does not swing. This is because the unit is being controlled by the micro computer.

11.1.4 Symptom: White mist comes out of a unit (Indoor unit)

- When humidity is high during cooling operation. If the interior of an indoor unit is extremely contaminated, the temperature distribution inside a room becomes uneven. It is necessary to clean the interior of the indoor unit. Ask your dealer for details on cleaning the unit. This operation requires a qualified service person.
- Immediately after the cooling operation stops and if the room temperature and humidity are low. This is because warm refrigerant gas flows back into the indoor unit and generates steam.

11.1.5 Symptom: White mist comes out of a unit (Indoor unit, outdoor unit)

When the system is changed over to heating operation after defrost operation. Moisture generated by defrost becomes steam and is exhausted.

11.1.6 Symptom: The user interface reads "U4" or "U5" and stops, but then restarts after a few minutes

This is because the user interface is intercepting noise from electric appliances other than the air conditioner. The noise prevents communication between the units, causing them to stop. Operation automatically restarts when the noise ceases. A power reset may help to remove this error.

11.1.7 Symptom: Noise of air conditioners (Indoor unit)

- A "zeen" sound is heard immediately after the power supply is turned on. The electronic expansion valve inside an indoor unit starts working and makes the noise. Its volume will reduce in about one minute.
- A continuous low "shah" sound is heard when the system is in cooling operation or at a stop. When the drain pump is in operation, this noise is heard.
- A "pishi-pishi" squeaking sound is heard when the system stops after heating operation. Expansion and contraction of plastic parts caused by temperature change make this noise.

11.1.8 Symptom: Noise of air conditioners (Indoor unit, outdoor unit)

- A continuous low hissing sound is heard when the system is in cooling or defrost operation. This is the sound of refrigerant gas flowing through both indoor and outdoor units.
- A hissing sound which is heard at the start or immediately after stopping operation or defrost operation. This is the noise of refrigerant caused by flow stop or flow change.

11.1.9 Symptom: Dust comes out of the unit

When the unit is used for the first time in a long time. This is because dust has gotten into the unit.

11.1.10 Symptom: The units can give off odours

The unit can absorb the smell of rooms, furniture, cigarettes, etc., and then emit it again.

11.1.11 Symptom: The fan runs after the unit is turned off via the user interface

- **Cooling mode:** After stopping the unit in cooling, the suction grill and flaps close. The indoor fan runs for 30 minutes to dry out inside of the unit, preventing mould and odours.
- **Heating mode:** To prevent dew condensation when stopping in heating during defrost, the fan runs for 6 minutes to dry out inside of the unit, preventing mould and odours.

12 Relocation

Contact your dealer to remove and reinstall the entire unit. Moving units requires technical expertise.

13 Disposal

**NOTICE**

Do NOT try to dismantle the system yourself: dismantling of the system, treatment of the refrigerant, oil and other parts **MUST** comply with applicable legislation. Units **MUST** be treated at a specialised treatment facility for reuse, recycling and recovery.

For the installer

14 About the box

Keep the following in mind:

- At delivery, the unit **MUST** be checked for damage and completeness. Any damage or missing parts **MUST** be reported immediately to the claims agent of the carrier.
- Bring the packed unit as close as possible to its final installation position to prevent damage during transport.
- Prepare in advance the path along which you want to bring the unit to its final installation position.
- When handling the unit, take into account the following:



Fragile, handle the unit with care.



Keep the unit upright in order to avoid damage.

14.1 Indoor unit

14.1.1 To unpack and handle the unit

Use a sling of soft material or protective plates together with a rope when lifting the unit in order to avoid damage or scratches to the unit.

- 1** Lift the unit by holding on to the hanger brackets without exerting any pressure on other parts, especially on refrigerant piping, drain piping and other resin parts.

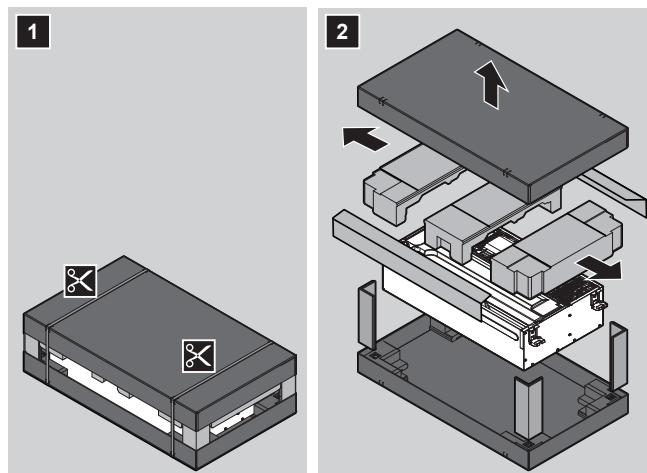

14.1.2 To remove the accessories from the indoor unit

- 1** Remove the accessories **A, B, C**:

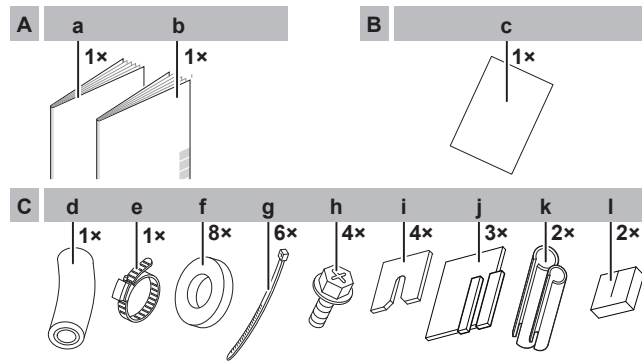

- A** Located under the unit
 - a** Installation and operation manual
 - b** General safety precautions

- B** Located under the unit
 - c** Paper pattern for installation

- C** Located on the side of the unit
 - d** Drain hose
 - e** Metal clamp
 - f** Clamp washer for hanger bracket
 - g** Tie wraps
 - h** Screw
 - i** Clamp washer for hanger bracket
 - j** Sealing pad: Large (drain piping), medium (gas piping) and small (liquid piping)
 - k** Insulation piece: Large (gas pipe), small (liquid pipe)
 - l** Sealing pad (for covering the cable bushing)

15 About the units and options

In this chapter

15.1	Identification.....	47
15.1.1	Identification label: Indoor unit.....	47
15.2	About the indoor unit.....	47
15.3	Components.....	47
15.4	Combining units and options.....	48
15.4.1	Possible options for the indoor unit.....	48

15.1 Identification



NOTICE

When installing or servicing several units at the same time, make sure NOT to switch the service panels between different models.

15.1.1 Identification label: Indoor unit

Location

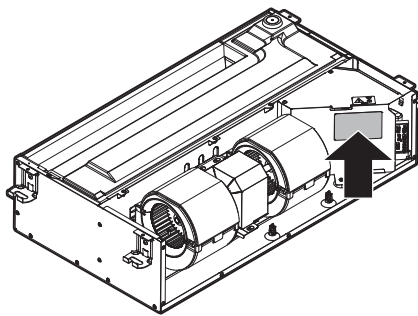

15.2 About the indoor unit



INFORMATION

For the operation limits see the technical data of the connected outdoor unit.

15.3 Components



INFORMATION

The following figure is an example and may NOT completely match your system layout

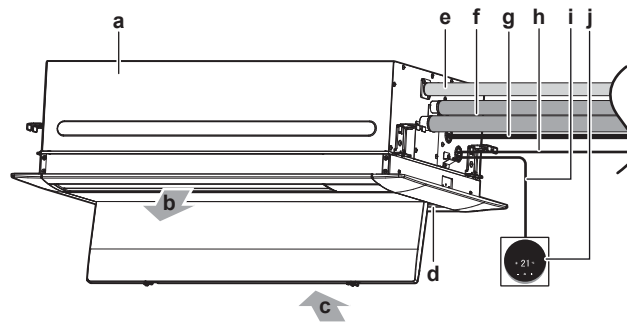

- a Indoor unit
- b Discharge air
- c Suction air
- d Air filter
- e Drain pipe
- f Refrigerant piping
- g Power supply cable
- h Interconnection cable
- i User interface cable
- j User interface

15.4 Combining units and options



INFORMATION

Certain options may NOT be available in your country.

15.4.1 Possible options for the indoor unit

Make sure you have the following mandatory options:

- Decoration panel
- User interface: Only a safety system compatible user interface can be used. See the technical data sheet for user interface compatibility (e.g. BRC1H52*)

Note: The user interface will generate a visible and audible warning in case of refrigerant leakage detection. E.g., BRC1H52* user interfaces can generate an alarm of 65 dB (sound pressure, measured at a distance of 1 m from the alarm). Sound data is available in the technical data sheet of the user interface. The alarm should always be 15 dB louder than the background noise of the room. In case of higher background noise we recommend connecting an external alarm (field supply) to the optional output PCB of the indoor unit. This field supplied alarm must be mounted in every room where an indoor unit is installed.



CAUTION

- Each indoor unit has to be connected to a separate user interface. Only a safety system compatible remote controller can be used as the user interface. See technical data sheet for remote controller compatibility (e.g. BRC1H52/82*).
 - The user interface has to be put in the same room as the indoor unit. For details, please refer to the installation and operation manual of the user interface.
- Optional output PCB (to provide output for external device): The PCB will trigger the external alarm in case of leak detection, sensor failure or when the sensor is disconnected. For the exact model name, see the option list of the indoor unit. For more information about this option, refer to the installation manual of the optional output PCB.

- An additional Installation box for the optional output PCB is required; see the option list of the indoor unit. For installation of the installation box, refer to the manual of the installation box. The wiring between the main PCB and the optional output PCB must be led together with the transmission cable; never use the same route as for the power supply cable. See "[18.2 To connect the electrical wiring to the indoor unit](#)" [▶ 67].

**INFORMATION**

All possible options are mentioned in the option list of the indoor unit. For more information about an option, refer to the installation and operation manual of the option.

16 Unit installation

In this chapter

16.1	Preparing the installation site	50
16.1.1	Installation site requirements of the indoor unit.....	50
16.2	Mounting the indoor unit.....	52
16.2.1	Guidelines when installing the indoor unit.....	52
16.2.2	Guidelines when installing the drain piping	54

16.1 Preparing the installation site

Choose an installation location with sufficient space to transport the unit in and out of the site.

Avoid installation in an environment with a lot of organic solvents such as ink and siloxane.

Do NOT install the unit in places often used as work place. In case of construction works (e.g. grinding works) where a lot of dust is created, the unit MUST be covered.



WARNING

The appliance shall be stored in a room without continuously operating ignition sources (example: open flames, an operating gas appliance or an operating electric heater).

16.1.1 Installation site requirements of the indoor unit

Minimum floor area requirements



CAUTION

The total refrigerant charge and/or releasable charge m_{r1} in the system cannot exceed the requirements for minimum floor area of the smallest room that is served. For minimum floor area requirements for indoor units, see the installation and operation manual of the outdoor unit.



INFORMATION

Also read the general installation site requirements. See the "[2 General safety precautions](#)" [▶ 6] chapter.



INFORMATION

The sound pressure level is less than 70 dBA.



CAUTION

Appliance NOT accessible to the general public, install it in a secured area, protected from easy access.

This unit, both indoor and outdoor, is suitable for installation in a commercial and light industrial environment.



WARNING

Keep any required ventilation openings clear of obstructions.

Do NOT install the unit in the following places:

- In places where a mineral oil mist, spray or vapour may be present in the atmosphere. Plastic parts may deteriorate and fall off or cause water leakage.

It is NOT recommended to install the unit in the following places because it may shorten the life of the unit:

- Where the voltage fluctuates a lot
- In vehicles or vessels
- Where acidic or alkaline vapour is present



NOTICE

The equipment described in this manual may cause electronic noise generated from radio-frequency energy. The equipment complies to specifications that are designed to provide reasonable protection against such interference. However, there is no guarantee that interference will NOT occur in a particular installation.

It is therefore recommended to install the equipment and electric wires in such a way that they keep a proper distance from stereo equipment, personal computers, etc.

In places with weak reception, keep distances of 3 m or more to avoid electromagnetic interference of other equipment and use conduit tubes for power and transmission lines.

- Take care that in the event of a water leak, water cannot cause any damage to the installation space and surroundings.
- Choose a location where the operation noise or the hot/cold air discharged from the unit will not disturb anyone and the location is selected according to the applicable legislation.
- **Drainage.** Make sure condensation water can be evacuated properly.
- **Paper pattern for installation** (accessory). Use the paper pattern when selecting the installation location. It contains the dimensions of the unit and locations of suspension bolts and piping connection side.
- **Spacing.** Mind the following requirements:

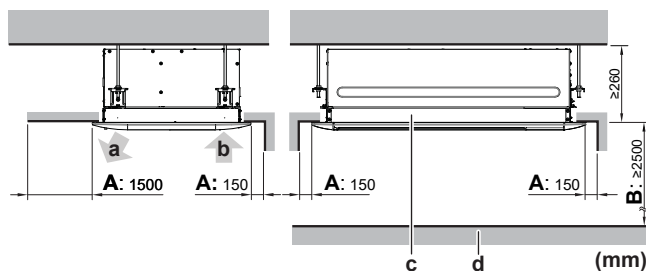

A Minimum distance to the wall

Minimum: 1.5 m on the air outlet side and 150 mm on the other sides

B Minimum and maximum distance to the floor

Minimum: 2.5 m to avoid accidental touching.
Maximum: 3.5 m. See "20.1 Field setting" [▶ 72].

- a Air outlet
- b Air inlet
- c Indoor unit
- d Floor



INFORMATION

Some options may require additional service space. See the installation manual of the used option before installation.

16.2 Mounting the indoor unit

16.2.1 Guidelines when installing the indoor unit



INFORMATION

Optional equipment. When installing optional equipment, also read the installation manual of the optional equipment. Depending on the field conditions, it might be easier to install the optional equipment first.

- **Ceiling strength.** Check whether the ceiling is strong enough to support the weight of the unit. If there is a risk, reinforce the ceiling before installing the unit.
 - For existing ceilings, use anchors.
 - For new ceilings, use sunken inserts, sunken anchors or other field supplied parts.

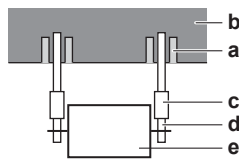

- a Anchor
- b Ceiling slab
- c Long nut or turnbuckle
- d Suspension bolt
- e Indoor unit

- **Suspension bolts and unit.** Use M10 suspension bolts for installation. Attach the hanger bracket to the suspension bolt. Fix it securely using a nut and washer on the top and bottom of the hanger bracket. Attached clamp washer for hanger bracket (accessory) can be used to prevent the washer for hanger bracket (accessory) from falling during installation. Remove the clamp washer for hanger bracket after the unit is mounted.

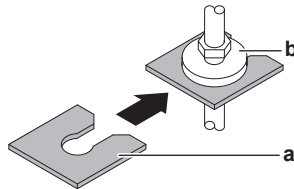

- a Clamp washer for hanger bracket (accessory)
- b Washer for hanger bracket (accessory)

Top view

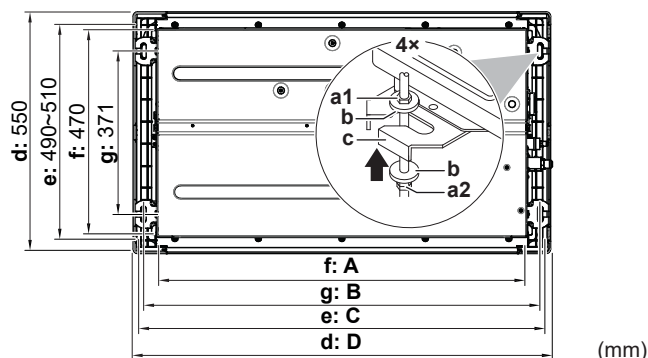

- a1 Top nut (field supply)
- a2 Bottom double nut (field supply)
- b Washer for hanger bracket (accessory)
- c Hanger bracket (attached to the unit)
- d Decoration panel dimensions

- e Ceiling opening dimensions
- f Indoor unit dimensions
- g Suspension bolt pitch

Class	A (mm)	B (mm)	C (mm)	D (mm)
20~32	840	903	860~910	950
40~63	1240	1303	1260~1310	1350

Side view

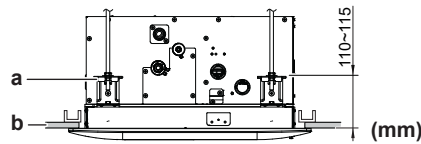

- a Suspension bolt
- b Ceiling



NOTICE

Make sure the decoration panel overlaps the ceiling opening by at least 20 mm. The distance between the indoor unit and the ceiling opening must be ≤ 35 mm; if it is more, install additional ceiling material or repair the ceiling.

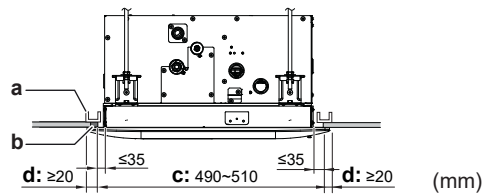

- a Frame
- b Additional ceiling material
- c Ceiling opening
- d Ceiling overlapping part of the decorative panel

To mount the indoor unit

- 1 Handle the unit only by the hanger brackets.

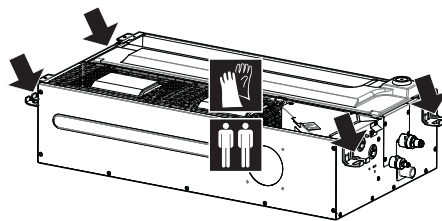

- 2 Temporarily hang the unit on the 2 suspension bolts on one side.
- 3 Insert the remaining 2 suspension bolts into the hanger bracket and fix it securely with the bottom washer and nut.

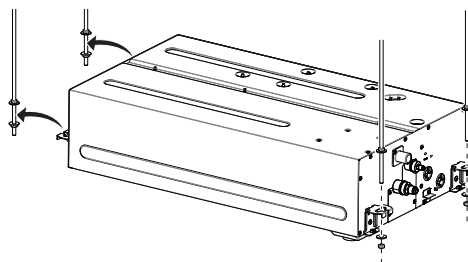

- 4 Make sure that the unit is level.

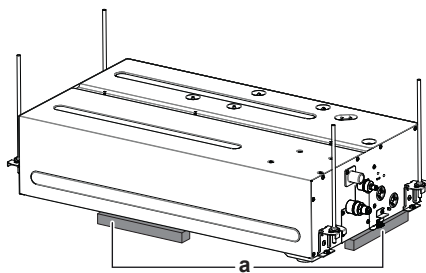

a Level



NOTICE

Do NOT install the unit tilted. **Possible consequence:** If the unit is tilted against the direction of the condensate flow (the drain piping side is raised), the float switch might malfunction and cause water to drip.

16.2.2 Guidelines when installing the drain piping

Make sure condensation water can be evacuated properly. This involves:

- General guidelines
- Connecting the drain piping to the indoor unit
- Checking for water leaks

General guidelines

- **Pipe length.** Keep drain piping as short as possible.
- **Pipe size.** Keep the pipe size equal to or greater than that of the connecting pipe (vinyl pipe of 25 mm nominal diameter and 32 mm outer diameter).
- **Slope.** Make sure the drain piping slopes down (at least 1/100) to prevent air from being trapped in the piping. Use hanging bars as shown.

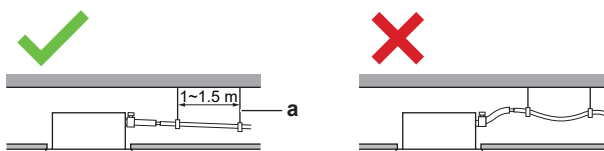

- a Hanging bar
- ✓ Allowed
- ✗ Not allowed

- **Condensation.** Take measures against condensation. Insulate the complete drain piping in the building.
- **Rising piping.** If necessary to make the slope possible, you can install rising piping.
 - Drain hose inclination: 0~75 mm to avoid stress on the piping and to avoid air bubbles.
 - Rising piping: ≤300 mm from the unit, ≤675 mm perpendicular to the unit.

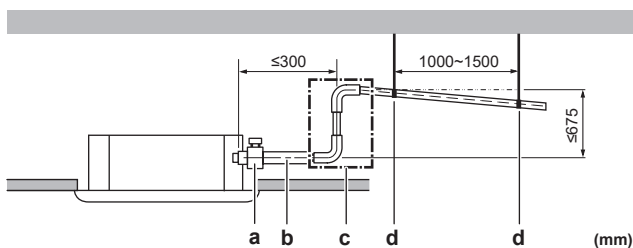

- a Metal clamp (accessory)
- b Drain hose (accessory)

- c Rising drain piping (vinyl pipe of 25 mm nominal diameter and 32 mm outer diameter) (field supply)
- d Hanging bars (field supply)

- **Combining drain pipes.** You can combine drain pipes. Make sure to use drain pipes and T-joints with the correct gauge for the operating capacity of the units.

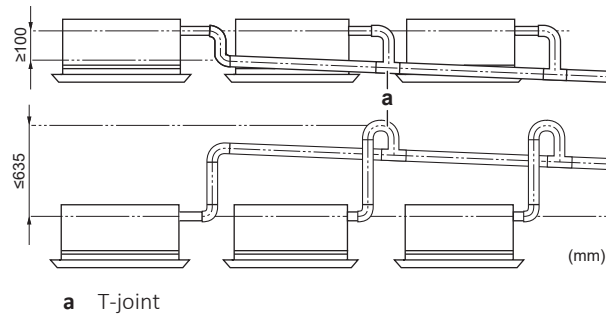

To connect the drain piping to the indoor unit



NOTICE

Incorrect connection of the drain hose might cause leaks, and damage the installation space and surroundings.

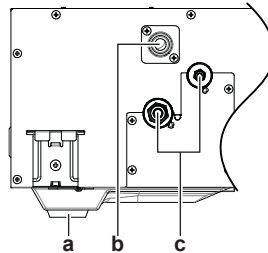

- a Drain outlet for maintenance
- b Drain pipe connection
- c Refrigerant pipes

Drain piping connection

- 1 Push the drain hose as far as possible over the drain pipe connection.
- 2 Wrap the vinyl tape around the drain hose under the metal clamp, ensuring it encircles the hose 2 or 3 times. The tape should extend beyond the width of the metal clamp for proper coverage.
- 3 Tighten the metal clamp until the screw head is less than 4 mm from the metal clamp part.
- 4 Check for water leaks (see "[To check for water leaks](#)" [▶ 56]).
- 5 Wind the large sealing pad (= insulation) around the metal clamp and drain hose, and fix it with tie wraps. Start wrapping from the tightened part of the metal clamp so that the end of the metal clamp is wrapped twice.
- 6 Connect the drain piping to the drain hose.

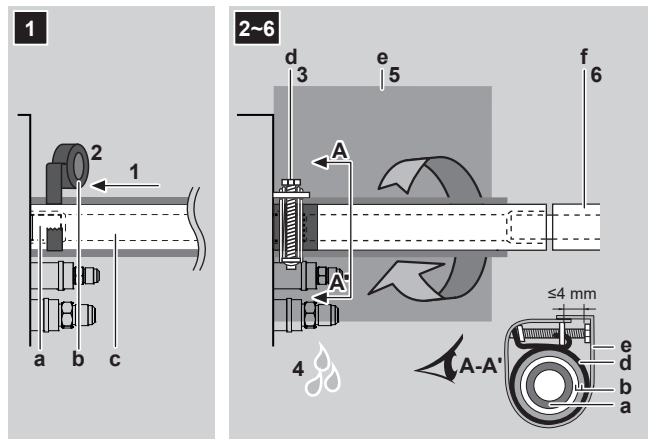

- a Drain pipe connection (attached to the unit)
- b Vinyl tape
- c Drain hose (accessory)
- d Metal clamp (accessory)
- e Large sealing pad (accessory)
- f Drain piping (field supply)

Drain outlet for maintenance

Pull out the plug.

- Do NOT wiggle the plug up and down.

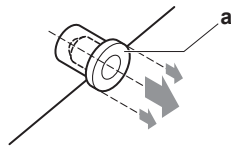

Push in the plug.

- Set the plug and push it in using a Phillips screwdriver.

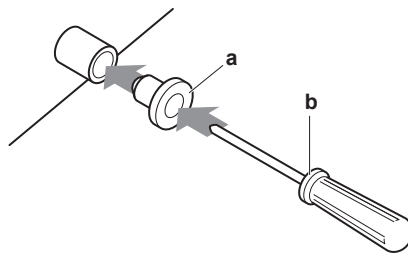

- a Drain plug
- b Phillips screwdriver

To check for water leaks

The procedure differs depending on whether installation of the system is already completed. When installation of the system is not yet completed, temporarily connect the user interface and power supply to the unit.

When installation of the system is not yet completed

- 1 Temporarily connect electrical wiring.
 - Remove the service cover. See ["18.2 To connect the electrical wiring to the indoor unit"](#) [▶ 67].
 - Connect the user interface (b).
 - Connect the power supply (a).
 - Reattach the service cover. See ["18.2 To connect the electrical wiring to the indoor unit"](#) [▶ 67].

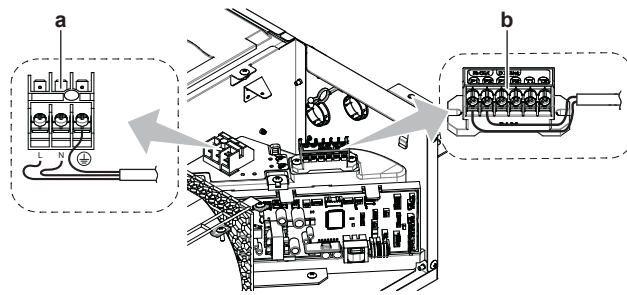

- a Power supply terminal block
- b User interface terminal block

- 2 Turn ON the power.
- 3 Start fan only operation (see the reference guide or the service manual of the user interface).
- 4 Gradually pour approximately 1 l of water through the air discharge outlet, and check for leaks.

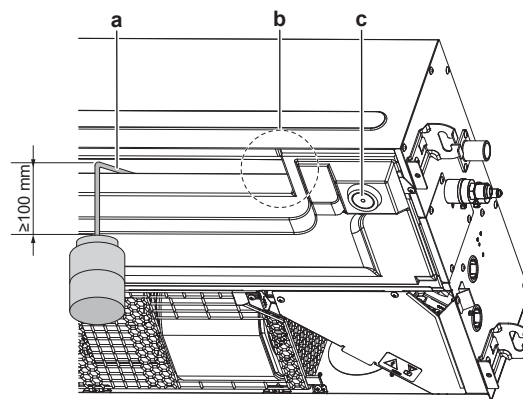

- a Plastic water container with tube length ≥ 100 mm
- b Drain pump and float switch location
- c Service drain outlet (with rubber plug). Use this outlet to drain water from the drain pan.

- 5 Turn OFF the power.
- 6 Disconnect the electrical wiring.
 - Remove the service cover. See ["18.2 To connect the electrical wiring to the indoor unit"](#) [▶ 67].
 - Disconnect the power supply.
 - Disconnect the user interface.
 - Reattach the service cover. See ["18.2 To connect the electrical wiring to the indoor unit"](#) [▶ 67].

When installation of the system is already completed

- 1 Start cooling operation (see the reference guide or the service manual of the user interface).
- 2 Gradually pour approximately 1 l of water through the water inlet, and check for leaks (see ["When installation of the system is not yet completed"](#) [▶ 56]).

17 Piping installation

In this chapter

17.1	Preparing refrigerant piping.....	58
17.1.1	Refrigerant piping requirements.....	58
17.1.2	Refrigerant piping insulation.....	59
17.2	Connecting the refrigerant piping.....	59
17.2.1	About connecting the refrigerant piping.....	59
17.2.2	Precautions when connecting the refrigerant piping.....	60
17.2.3	Guidelines when connecting the refrigerant piping.....	61
17.2.4	Pipe bending guidelines.....	61
17.2.5	To flare the pipe end.....	61
17.2.6	To connect the refrigerant piping to the indoor unit.....	62

17.1 Preparing refrigerant piping

17.1.1 Refrigerant piping requirements

 **CAUTION**
Piping **MUST** be installed according to instructions given in "[17 Piping installation](#)" [▶ 58]. Only mechanical joints (e.g. braze+flare connections) that are compliant with the latest version of ISO14903 can be used.

 **CAUTION**

- When **mechanical** connectors are re-used indoors, renew the sealing parts.
- When **flared joints** are re-used indoors, re-make the flared part.

 **NOTICE**
The piping and other pressure-containing parts shall be suitable for refrigerant. Use phosphoric acid deoxidised seamless copper for refrigerant piping.

 **INFORMATION**
Also read the precautions and requirements in the "[2 General safety precautions](#)" [▶ 6].

- Foreign materials inside pipes (including oils for fabrication) must be ≤30 mg/10 m.

Refrigerant piping diameter

For piping connections of the indoor unit use the following piping diameters:

Class	Pipe outer diameter (mm)	
	Liquid piping	Gas piping
20~32	Ø6.4 mm	Ø9.5 mm
40~63	Ø6.4 mm	Ø12.7 mm

Refrigerant piping material

- **Piping material:** phosphoric acid deoxidised seamless copper
- **Flare connections:** Only use annealed material.
- **Piping temper grade and thickness:**

Outer diameter (ϕ)	Temper grade	Thickness (t) ^(a)	
6.4 mm (1/4")	Annealed (O)	≥0.8 mm	
9.5 mm (3/8")			
12.7 mm (1/2")			

^(a) Depending on the applicable legislation and the maximum working pressure of the unit (see "PS High" on the unit name plate), larger piping thickness might be required.

17.1.2 Refrigerant piping insulation

- Use polyethylene foam as insulation material:
 - with a heat transfer rate between 0.041 and 0.052 W/mK (0.035 and 0.045 kcal/mh°C)
 - with a heat resistance of at least 120°C
- Insulation thickness:

Pipe outer diameter (ϕ_p)	Insulation inner diameter (ϕ_i)	Insulation thickness (t)
6.4 mm (1/4")	8~10 mm	≥10 mm
9.5 mm (3/8")	10~14 mm	≥13 mm
12.7 mm (1/2")	14~16 mm	≥13 mm



If the temperature is higher than 30°C and the humidity is higher than RH 80%, the thickness of the insulation materials should be at least 20 mm to prevent condensation on the surface of the insulation.

17.2 Connecting the refrigerant piping

17.2.1 About connecting the refrigerant piping

Before connecting the refrigerant piping

Make sure the outdoor and indoor unit are mounted.

Typical workflow

Connecting the refrigerant piping involves:

- Connecting the refrigerant piping to the indoor unit
- Connecting the refrigerant piping to the outdoor unit
- Insulating the refrigerant piping
- Keeping in mind the guidelines for:
 - Pipe bending
 - Flaring pipe ends
 - Using the stop valves

17.2.2 Precautions when connecting the refrigerant piping

i **INFORMATION**
 Also read the precautions and requirements in the following chapters:

- "2 General safety precautions" [▶ 6]
- "17.1 Preparing refrigerant piping" [▶ 58]

 **DANGER: RISK OF BURNING/SCALDING**

! **NOTICE**

- Do NOT use mineral oil on flared part.
- Do NOT reuse piping from previous installations.
- NEVER install a drier to this R32 unit to guarantee its lifetime. The drying material may dissolve and damage the system.

! **NOTICE**

- Use the flare nut fixed to the main unit.
- To prevent gas leakage, apply refrigeration oil only to the inside of the flare. Use refrigeration oil for R32 (**Example:** FW68DA).
- Do NOT reuse joints.

! **NOTICE**
 Take the following precautions on refrigerant piping into account:

- Avoid anything but the designated refrigerant to get mixed into the refrigerant cycle (e.g. air).
- Only use R32 when adding refrigerant.
- Only use installation tools (e.g. manifold gauge set) that are exclusively used for R32 installations to withstand the pressure and to prevent foreign materials (e.g. mineral oils and moisture) from mixing into the system.
- Install the piping so that the flare is NOT subjected to mechanical stress.
- Do NOT leave pipes unattended at the site. If the installation is NOT done within 1 day, protect the piping as described in the following table to prevent dirt, liquid or dust from entering the piping.
- Use caution when passing copper tubes through walls (see figure below).

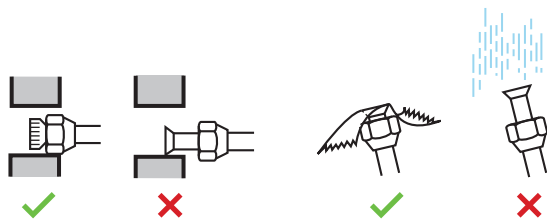

Unit	Installation period	Protection method
Outdoor unit	>1 month	Pinch the pipe
	<1 month	Pinch or tape the pipe
Indoor unit	Regardless of the period	

**NOTICE**

Do NOT open the refrigerant stop valve before checking the refrigerant piping. When you need to charge additional refrigerant it is recommended to open the refrigerant stop valve after charging.

17.2.3 Guidelines when connecting the refrigerant piping

Take the following guidelines into account when connecting pipes:

- Coat the flare inner surface with ether oil or ester oil when connecting a flare nut. Tighten 3 or 4 turns by hand, before tightening firmly.

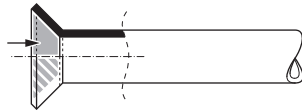

- ALWAYS use 2 wrenches together when loosening a flare nut.
- ALWAYS use a spanner and torque wrench together to tighten the flare nut when connecting the piping. This to prevent nut cracking and leaks.

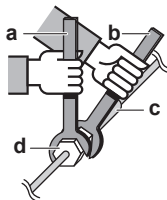

- a Torque wrench
- b Spanner
- c Piping union
- d Flare nut

Piping size (mm)	Tightening torque (N•m)	Flare dimensions (A) (mm)	Flare shape (mm)
∅6.4	15~17	8.7~9.1	
∅9.5	33~39	12.8~13.2	
∅12.7	50~60	16.2~16.6	

17.2.4 Pipe bending guidelines

Use a pipe bender for bending. All pipe bends should be as gentle as possible (bending radius should be 30~40 mm or larger).

17.2.5 To flare the pipe end

**CAUTION**

- Incomplete flaring may cause refrigerant gas leakage.
- Do NOT re-use flares. Use new flares to prevent refrigerant gas leakage.
- Use flare nuts that are included with the unit. Using different flare nuts may cause refrigerant gas leakage.

- 1 Cut the pipe end with a pipe cutter.
- 2 Remove burrs with the cut surface facing down so that the chips do NOT enter the pipe.

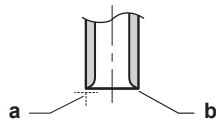

- a Cut exactly at right angles.
- b Remove burrs.

- 3 Remove the flare nut from the stop valve and put the flare nut on the pipe.
- 4 Flare the pipe. Set exactly at the position as shown in the following figure.

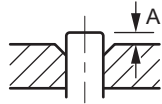

	Flare tool for R32 (clutch type)	Conventional flare tool	
		Clutch type (Rigid-type)	Wing nut type (Imperial-type)
A	0~0.5 mm	1.0~1.5 mm	1.5~2.0 mm

- 5 Check that the flaring is properly made.

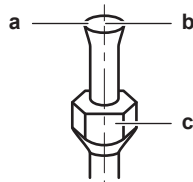

- a Flare's inner surface MUST be flawless.
- b The pipe end MUST be evenly flared in a perfect circle.
- c Make sure the flare nut is fitted.

17.2.6 To connect the refrigerant piping to the indoor unit



CAUTION

Install the refrigerant piping or components in a position where they are unlikely to be exposed to any substance which may corrode components containing refrigerant, unless the components are constructed of materials that are inherently resistant to corrosion or are suitably protected against corrosion.



A2L

WARNING: MILDLY FLAMMABLE MATERIAL

The refrigerant inside this unit is mildly flammable.

- **Pipe length.** Keep refrigerant piping as short as possible.
- **Flare connections.** Connect refrigerant piping to the unit using flare connections.
- **Insulation.** Insulate the refrigerant piping on the indoor unit as follows:

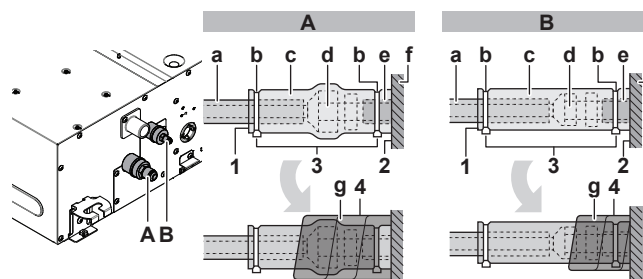

- A Gas piping
- B Liquid piping

- a Insulation material (field supply)

- b** Tie wrap (accessory)
 - c** Insulation pieces: Large (gas pipe), small (liquid pipe) (accessories)
 - d** Flare nut (attached to the unit)
 - e** Refrigerant pipe connection (attached to the unit)
 - f** Unit
 - g** Sealing pads: Medium (gas pipe), Small (liquid pipe) (accessories)
- 1** Turn up the seams of the insulation pieces.
 - 2** Attach to the base of the unit.
 - 3** Tighten the tie wrap on the insulation pieces.
 - 4** Wrap the sealing pad from the base of the unit to the top of the flare nut.

**NOTICE**

Make sure to insulate all refrigerant piping. Any exposed piping might cause condensation.

18 Electrical installation

In this chapter

18.1	About connecting the electrical wiring	64
18.1.1	Precautions when connecting the electrical wiring	64
18.1.2	Guidelines when connecting the electrical wiring	65
18.1.3	Specifications of standard wiring components	66
18.2	To connect the electrical wiring to the indoor unit	67

18.1 About connecting the electrical wiring

Typical workflow

Connecting the electrical wiring typically consists of the following stages:

- 1 Making sure the power supply system complies with the electrical specifications of the units.
- 2 Connecting the electrical wiring to the outdoor unit.
- 3 Connecting the electrical wiring to the indoor unit.
- 4 Connecting the main power supply.

18.1.1 Precautions when connecting the electrical wiring



DANGER: RISK OF ELECTROCUTION



WARNING

- All wiring **MUST** be performed by an authorised electrician and **MUST** comply with the national wiring regulation.
- Make electrical connections to the fixed wiring.
- All components procured on-site and all electrical construction **MUST** comply with the applicable legislation.



WARNING

ALWAYS use multicore cable for power supply cables.



INFORMATION

Also read the precautions and requirements in the "[2 General safety precautions](#)" [[▶ 6](#)].



INFORMATION

Also read "[18.1.3 Specifications of standard wiring components](#)" [[▶ 66](#)].

**WARNING**

- If the power supply has a missing or wrong N-phase, equipment might break down.
- Establish proper earthing. Do NOT earth the unit to a utility pipe, surge absorber, or telephone earth. Incomplete earthing may cause electrical shocks.
- Install the required fuses or circuit breakers.
- Secure the electrical wiring with cable ties so that the cables do NOT come in contact with sharp edges or piping, particularly on the high-pressure side.
- Do NOT use taped wires, extension cords, or connections from a star system. They can cause overheating, electrical shocks or fire.
- Do NOT install a phase advancing capacitor, because this unit is equipped with an inverter. A phase advancing capacitor will reduce performance and may cause accidents.

**WARNING**

If NOT factory installed, a main switch or other means for disconnection, having a contact separation in all poles providing full disconnection under overvoltage category III condition, MUST be installed in the fixed wiring.

**WARNING**

If the supply cord is damaged, it MUST be replaced by the manufacturer, its service agent or similarly qualified persons in order to avoid a hazard.

18.1.2 Guidelines when connecting the electrical wiring

**NOTICE**

We recommend using solid (single-core) wires. If stranded wires are used, slightly twist the strands to consolidate the end of the conductor for either direct use in the terminal clamp or insertion in a round crimp-style terminal.

To prepare stranded conductor wire for installation

Method 1: Twisting conductor

- 1 Strip insulation (20 mm) from the wires.
- 2 Slightly twist the end of the conductor to create a "solid-like" connection.

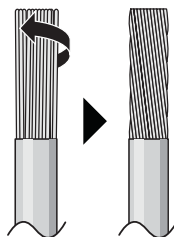

Method 2: Using round crimp-style terminal

- 1 Strip insulation from wires and slightly twist the end of each wire.
- 2 Install a round crimp-style terminal on the end of the wire. Place the round crimp-style terminal on the wire up to the covered part and fasten the terminal with the appropriate tool.

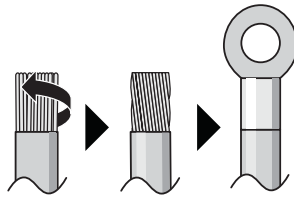

Use the following methods for installing wires:

Wire type	Installation method
Single-core wire Or Stranded conductor wire twisted to "solid-like" connection	<p>a Curled wire (single-core or twisted stranded conductor wire) b Screw c Flat washer</p>
Stranded conductor wire with round crimp-style terminal	<p>a Terminal b Screw c Flat washer ✓ Allowed ✗ NOT allowed</p>

Tightening torques

Wiring	Screw size	Tightening torque (N•m)
Power supply cable	M4	1.3~1.6
Transmission cable (indoor↔outdoor)	M3.5	0.79~0.97
User interface cable		

- The earth wire between the wire retainer and the terminal must be longer than the other wires.



18.1.3 Specifications of standard wiring components

Power supply of the product	
Voltage	220~240 V/220 V
Frequency	50/60 Hz
Phase	1~

Power supply of the product	
MCA ^(a)	FXKA20, 25, 32: 0.4 A FXKA40: 0.6 A FXKA50: 0.9 A FXKA63: 1.4 A

^(a) MCA=Minimum circuit ampacity. Stated values are maximum values (see electrical data of indoor unit for exact values).

Wiring / circuit breaker (field supplied)	
Power supply cable	MUST comply with national wiring regulation. 3-core cable Wire size based on the current, but not less than 1.5 mm ²
Transmission wiring	Only use harmonised wire providing double insulation and suitable for applicable voltage 2-core cable Minimum size 0.75 mm ²
User interface cable	Only use harmonised wire providing double insulation and suitable for applicable voltage 2-core cable Minimum size 0.75 mm ² Maximum length 500 m
Recommended circuit breaker	6 A
Residual current device	MUST comply with national wiring regulation

18.2 To connect the electrical wiring to the indoor unit



NOTICE

- Follow the wiring diagram (delivered with the unit, located at the inside of the service cover).
- For instructions on how to connect the optional equipment, see the installation manual delivered with the optional equipment.
- Make sure the electrical wiring does NOT obstruct proper reattachment of the service cover.

It is important to keep the power supply and the transmission wiring separated from each other. In order to avoid any electrical interference the distance between both wirings should ALWAYS be at least 50 mm.



NOTICE

Be sure to keep the power line and transmission line apart from each other. Transmission wiring and power supply wiring may cross, but may NOT run parallel.

- 1 Remove the service cover.** Remove the 2 screws. Hold the service cover by the handle and slide it in the direction of the arrow and then toward you.

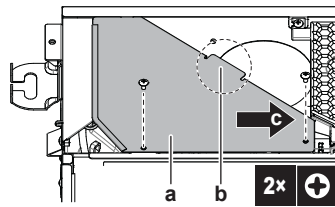

- a Service cover
- b Service cover handle
- c Sliding direction of service cover

2 User interface cable: Route the cable through the frame and connect it to the terminal block (P1, P2).

3 Transmission cable: Route the cable through the frame and connect it to the terminal block (make sure the symbols F1 and F2 match with the symbols on the outdoor unit).

4 Power supply cable: Route the cable through the frame and connect it to the terminal block (L, N, earth).

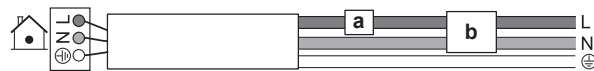

- a Circuit breaker
- b Residual current device

5 Plastic clamp for tie wrap: Pass tie wraps through the plastic clamps and fasten to fix the cables.

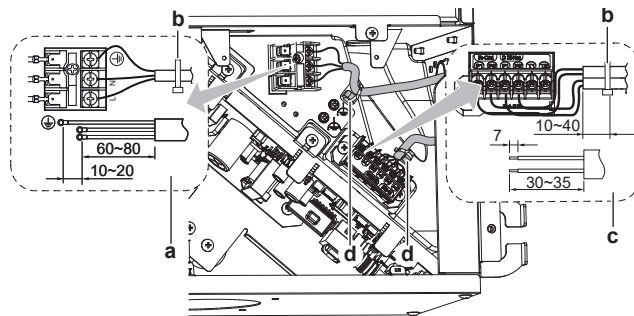

- a Connection of power supply cable
- b Tie wrap (accessory)
- c Connection of user interface cable and transmission cable
- d Plastic clamp for tie wrap

6 Stick the sealing pads (accessory) to cover the cable bushing.

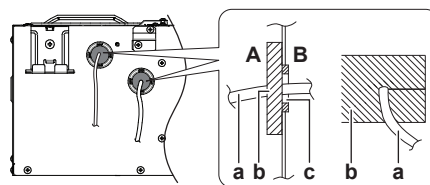

- A Outside the unit
- B Inside the unit
- a Cable
- b Sealing pad (accessory)
- c Opening for cables

7 Reattach the service cover. Slide the service cover back and fix with 2 screws.

Complete system example

1 user interface controls 1 indoor unit.

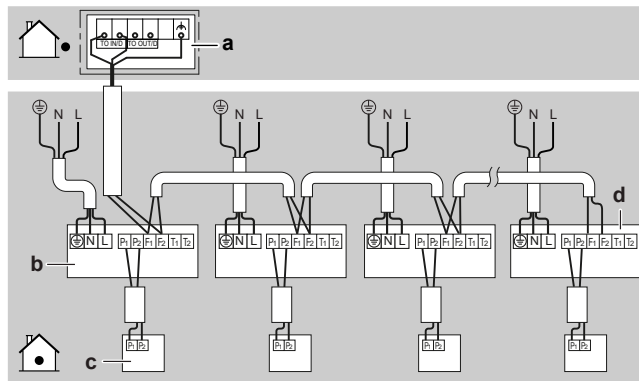

- a Outdoor unit
- b Indoor unit
- c User interface
- d Most downstream indoor unit

**NOTICE**

For the use of group control and related limitations refer to manual of outdoor unit.

**CAUTION**

- Each indoor unit has to be connected to a separate user interface. Only a safety system compatible remote controller can be used as the user interface. See technical data sheet for remote controller compatibility (e.g. BRC1H52/82*).
- The user interface has to be put in the same room as the indoor unit. For details, please refer to the installation and operation manual of the user interface.

**CAUTION**

In case shielded wire is used, connect the shielding to the outdoor unit side only.

19 Commissioning



NOTICE

General commissioning checklist. Next to the commissioning instructions in this chapter, a general commissioning checklist is also available on the Daikin Business Portal (authentication required).

The general commissioning checklist is complementary to the instructions in this chapter and can be used as a guideline and reporting template during commissioning and hand-over to the user.

In this chapter

19.1	Overview: Commissioning	70
19.2	Precautions when commissioning.....	70
19.3	Checklist before commissioning.....	71
19.4	To perform a test run	71

19.1 Overview: Commissioning

This chapter describes what you have to do and know to commission the system after it is installed.

Typical workflow

Commissioning typically consists of the following stages:

- 1 Checking the "Checklist before commissioning".
- 2 Performing a test run for the system.

19.2 Precautions when commissioning



NOTICE

Before starting up the system, the unit **MUST** be energised for at least 6 hours to avoid compressor breakdown during startup.



NOTICE

ALWAYS operate the unit with thermistors and/or pressure sensors/switches. If **NOT**, burning of the compressor might be the result.



NOTICE

ALWAYS complete the refrigerant piping of the unit before operating. If **NOT**, the compressor will break.



NOTICE

Cooling operation mode. Perform the test run in cooling operation mode so that stop valves failing to open can be detected. Even if the user interface was set to heating operation mode, the unit will run in cooling operation mode during 2-3 minutes (although the user interface will display the heating icon), and then automatically switch to heating operation mode.

**INFORMATION**

During the first running period of the unit, the required power may be higher than stated on the nameplate of the unit. This phenomenon is caused by the compressor, that needs a continuous run time of 50 hours before reaching smooth operation and stable power consumption.

19.3 Checklist before commissioning

- 1 After the installation of the unit, check the items listed below.
- 2 Close the unit.
- 3 Power up the unit.

<input type="checkbox"/>	You have read the complete installation and operation instructions described in the installer and user reference guide .
<input type="checkbox"/>	The indoor unit is properly mounted.
<input type="checkbox"/>	The outdoor unit is properly mounted.
<input type="checkbox"/>	The drain piping is properly installed and insulated, and drainage flows smoothly. Check for water leaks. Possible consequence: condensate water might drip.
<input type="checkbox"/>	The refrigerant pipes (gas and liquid) are installed correctly and thermally insulated.
<input type="checkbox"/>	There are NO refrigerant leaks .
<input type="checkbox"/>	There are NO missing phases or reversed phases .
<input type="checkbox"/>	The system is properly earthed and the earth terminals are tightened.
<input type="checkbox"/>	The fuses or locally installed protection devices are installed according to this document, and have NOT been bypassed.
<input type="checkbox"/>	The power supply voltage matches the voltage on the identification label of the unit.
<input type="checkbox"/>	There are NO loose connections or damaged electrical components in the switch box.
<input type="checkbox"/>	There are NO damaged components or squeezed pipes on the inside of the indoor and outdoor units.
<input type="checkbox"/>	The stop valves (gas and liquid) on the outdoor unit are fully open.

19.4 To perform a test run

**INFORMATION**

- Perform the test run according to the instructions in the outdoor unit manual.
- The test run is only completed if there is no malfunction code displayed on the user interface or the outdoor unit 7-segment display.
- See the service manual for the complete list of error codes and a detailed troubleshooting guideline for each error.

**NOTICE**

Do **NOT** interrupt the test run.

20 Configuration

20.1 Field setting

Make the following field settings so that they correspond with the actual installation setup and with the needs of the user:

- Ceiling height
- Air volume when thermostat control is OFF
- Time to clean air filter
- Thermostat sensor selection
- Thermostat differential changeover (if remote sensor is used)
- Automatic changeover differential
- Auto-restart after power failure
- T1/T2 input setting
- Mold proof prevention operation



INFORMATION

- The connection of optional accessories to the indoor unit might cause changes to some field settings. For more information, see the installation manual of the optional accessory.
- Following setting are only applicable when using the BRC1H52* user interface. When using any other user interface, see the installation manual or service manual of the user interface.

Setting: Ceiling height

This setting must correspond with the actual distance to the floor.

If the distance to the floor is (m)	Then ⁽¹⁾		
	M	SW	—
≤2.7	13 (23)	0	01
2.7<x≤3.0			02
3.0<x≤3.5			03

Setting: Air volume when thermostat control is OFF

This setting must correspond with the needs of the user. It determines the fan speed of the indoor unit during thermostat OFF condition.

- 1 If you have set the fan to operate, set the air volume speed:

⁽¹⁾ Field settings are defined as follows:

- **M**: Mode number – **First number**: for group of units – **Number between brackets**: for individual unit
- **SW**: Setting number
- **—**: Value number
- : Default

If you want...		Then ⁽¹⁾		
		M	SW	—
During thermostat OFF at cooling operation	LL ⁽²⁾	12 (22)	6	01
	Setup volume ⁽²⁾			02
	OFF ^(a)			03
	Monitoring 1 ⁽²⁾			04
	Monitoring 2 ⁽²⁾			05
During thermostat OFF at heating operation	LL ⁽²⁾	12 (22)	3	01
	Setup volume ⁽²⁾			02
	OFF ^(a)			03
	Monitoring 1 ⁽²⁾			04
	Monitoring 2 ⁽²⁾			05

^(a) Only use in combination with optional remote sensor or when setting **M** 10 (20), **SW** 2, — 03 is used.

Setting: Time to clean air filter

This setting must correspond with the air contamination in the room. It determines the interval at which "Time to clean filter" notification is displayed on the user interface.

If you want an interval of... (air contamination)	Then ⁽¹⁾		
	M	SW	—
±2500 h (light)	10 (20)	0	01
±1250 h (heavy)			02
Notification ON		3	01
Notification OFF			02

Setting: Thermostat sensor selection

This setting must correspond with how/if the remote controller thermostat sensor is used.

When the remote controller thermostat sensor is...	Then ⁽¹⁾		
	M	SW	—
Used in combination with indoor unit thermistor	10 (20)	2	01
Not used (indoor unit thermistor only)			02
Used exclusively			03

⁽¹⁾ Field settings are defined as follows:

- **M**: Mode number – **First number**: for group of units – **Number between brackets**: for individual unit
- **SW**: Setting number
- —: Value number
- : Default

⁽²⁾ Fan speed:

- **LL**: Low fan speed (set during thermostat OFF)
- **L**: Low fan speed (set by the user interface)
- **Setup volume**: The fan speed corresponds to the speed the user has set (low, medium, high) using the fan speed button on the user interface.
- **Monitoring 1, 2**: The fan is OFF, but runs for a short time every 6 minutes to detect the room temperature by **LL** (Monitoring 1) or by **L** (Monitoring 2).

Setting: Thermostat differential changeover (if remote sensor is used)

If the system contains a remote sensor, set the increase/decrease increments.

If you want to change increments to...	Then ⁽¹⁾		
	M	SW	—
1°C	12 (22)	2	01
0.5°C			02

Setting: Automatic changeover differential

Set temperature difference between cooling setpoint and heating setpoint in automatic mode (availability depends on the system type). Differential is cooling setpoint minus heating setpoint.

If you want to set...	Then ⁽¹⁾			Example
	M	SW	—	
0°C	12 (22)	4	01	cooling 24°C/heating 24°C
1°C			02	cooling 24°C/heating 23°C
2°C			03	cooling 24°C/heating 22°C
3°C			04	cooling 24°C/heating 21°C
4°C			05	cooling 24°C/heating 20°C
5°C			06	cooling 24°C/heating 19°C
6°C			07	cooling 24°C/heating 18°C
7°C			08	cooling 24°C/heating 17°C

Setting: Auto-restart after power failure

Depending on the needs of the user, you may disable/enable the automatic restart after a power failure.

If you want auto-restart after power failure...	Then ⁽¹⁾		
	M	SW	—
Disabled	12 (22)	5	01
Enabled			02

Setting: T1/T2 input setting



WARNING

In case of R32 refrigerant, terminal connections T1/T2 are for fire alarm input ONLY. Fire alarm has a higher priority than R32 safety and shuts the entire system down.

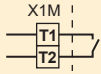

a Fire alarm input signal (potential free contact)

Remote control is available by transmission the external input to the terminals T1 and T2 on the terminal block for the user interface and the transmission wiring.

⁽¹⁾ Field settings are defined as follows:

- **M**: Mode number – **First number**: for group of units – **Number between brackets**: for individual unit
- **SW**: Setting number
- **—**: Value number
- **■**: Default

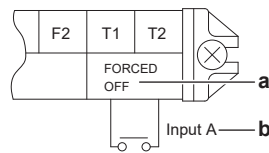

- a** Forced OFF
b Input A

Wiring requirements	
Wiring specification	Sheathed vinyl cord or 2-core cable
Wiring size	0.75~1.25 mm ²
Wiring length	Maximum 100 m
External contact specification	Contact that can make and break the min. load of DC15 V · 1 mA

This setting must correspond with the needs of the user.

If you want to set...	Then ⁽¹⁾		
	M	SW	—
Forced OFF	12 (22)	1	01
ON/OFF Operation			02
Emergency (recommended for alarm operation)			03
Forced OFF - multi tenant			04
Interlocking setting A			05
Interlocking setting B			06

Setting: Mold proof prevention operation



NOTICE

When the function is disabled, mould and odour may form inside the indoor unit.

This setting must correspond with the needs of the user. It determines the fan operation time after the unit is turned off by the user interface during cooling mode.

If you want to set the fan operation time after the unit is turned off to...	Then ⁽¹⁾		
	M	SW	—
Disabled	14 (24)	10	01
30 minutes			02
60 minutes			03

⁽¹⁾ Field settings are defined as follows:

- **M**: Mode number – **First number**: for group of units – **Number between brackets**: for individual unit
- **SW**: Setting number
- **—**: Value number
- : Default

21 Hand-over to the user

Once the test run is finished and the unit operates properly, make sure the following is clear for the user:

- Make sure that the user has the printed documentation and ask him/her to keep it for future reference. Inform the user that he can find the complete documentation at the URL mentioned earlier in this manual.
- Explain the user how to properly operate the system and what to do in case of problems.
- Show the user what to do for the maintenance of the unit.

22 Troubleshooting

22.1 Solving problems based on error codes

If the unit runs into a problem, the user interface displays an error code. It is important to understand the problem and to take measures before resetting an error code. This should be done by a licensed installer or by your local dealer.

This chapter gives you an overview of most possible error codes and their descriptions as they appear on the user interface.



INFORMATION

See the service manual for:

- The complete list of error codes
- A more detailed troubleshooting guideline for each error

22.1.1 Error codes: Overview

In case other error codes appear, contact your dealer.

Code	Description
<i>RD-11</i>	The R32 sensor has detected a refrigerant leak
<i>RD/CH</i>	Safety system error (leak detection)
<i>CH-01</i>	R32 sensor malfunction
<i>CH-02</i>	R32 sensor end of lifetime
<i>CH-05</i>	6 months before the R32 sensor end of lifetime
<i>R1</i>	Malfunction of indoor unit PCB
<i>R3</i>	Drain level control system abnormality
<i>R4</i>	Malfunction of freezing protection
<i>R5</i>	High pressure control in heating, freeze-up protection control in cooling
<i>R6</i>	Malfunction of fan motor
<i>R7</i>	Malfunction of swing flap motor
<i>R8</i>	Malfunction of power supply or AC input overcurrent
<i>R9</i>	Malfunction of electronic expansion valve
<i>RF</i>	Malfunction of a humidifier system
<i>RH</i>	Malfunction of dust collector of air cleaner
<i>RJ</i>	Malfunction of capacity setting (Indoor unit PCB)
<i>C1</i>	Failure of transmission (between indoor unit PCB and sub PCB)
<i>C4</i>	Malfunction of liquid pipe thermistor for heat exchanger
<i>C5</i>	Malfunction of gas pipe thermistor for heat exchanger
<i>C6</i>	Malfunction of gas pipe thermistor for heat exchanger
<i>C9</i>	Malfunction of suction air thermistor
<i>CR</i>	Malfunction of discharge air thermistor

Code	Description
EJ	Room temperature thermistor in remote controller abnormality

23 Disposal

**NOTICE**

Do NOT try to dismantle the system yourself: dismantling of the system, treatment of the refrigerant, oil and other parts **MUST** comply with applicable legislation. Units **MUST** be treated at a specialised treatment facility for reuse, recycling and recovery.

















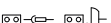

24 Technical data

- A **subset** of the latest technical data is available on the regional Daikin website (publicly accessible).
- The **full set** of the latest technical data is available on the Daikin Business Portal (authentication required).

24.1 Wiring diagram

24.1.1 Unified wiring diagram legend

For applied parts and numbering, refer to the wiring diagram on the unit. Part numbering is by Arabic numbers in ascending order for each part and is represented in the overview below by "*" in the part code.

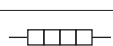
Symbol	Meaning	Symbol	Meaning
	Circuit breaker		Protective earth
			
			
	Connection		Protective earth (screw)
	Connector		Rectifier
	Earth		Relay connector
	Field wiring		Short-circuit connector
	Fuse		Terminal
	Indoor unit		Terminal strip
	Outdoor unit		Wire clamp
	Residual current device		Heater

Symbol	Colour	Symbol	Colour
BLK	Black	ORG	Orange
BLU	Blue	PNK	Pink
BRN	Brown	PRP, PPL	Purple
GRN	Green	RED	Red
GRY	Grey	WHT	White
SKY BLU	Sky blue	YLW	Yellow

Symbol	Meaning
A*P	Printed circuit board
BS*	Pushbutton ON/OFF, operation switch
BZ, H*O	Buzzer
C*	Capacitor

Symbol	Meaning
AC*, CN*, E*, HA*, HE*, HL*, HN*, HR*, MR*_A, MR*_B, S*, U, V, W, X*A, K*R_*, NE	Connection, connector
D*, V*D	Diode
DB*	Diode bridge
DS*	DIP switch
E*H	Heater
FU*, F*U, (for characteristics, refer to PCB inside your unit)	Fuse
FG*	Connector (frame ground)
H*	Harness
H*P, LED*, V*L	Pilot lamp, light emitting diode
HAP	Light emitting diode (service monitor green)
HIGH VOLTAGE	High voltage
IES	Intelligent eye sensor
IPM*	Intelligent power module
K*R, KCR, KFR, KHuR, K*M	Magnetic relay
L	Live
L*	Coil
L*R	Reactor
M*	Stepper motor
M*C	Compressor motor
M*F	Fan motor
M*P	Drain pump motor
M*S	Swing motor
MR*, MRCW*, MRM*, MRN*	Magnetic relay
N	Neutral
n=*, N=*	Number of passes through ferrite core
PAM	Pulse-amplitude modulation
PCB*	Printed circuit board
PM*	Power module
PS	Switching power supply
PTC*	PTC thermistor
Q*	Insulated gate bipolar transistor (IGBT)
Q*C	Circuit breaker
Q*DI, KLM	Earth leak circuit breaker
Q*L	Overload protector

Symbol	Meaning
Q*M	Thermo switch
Q*R	Residual current device
R*	Resistor
R*T	Thermistor
RC	Receiver
S*C	Limit switch
S*L	Float switch
S*NG	Refrigerant leak detector
S*NPH	Pressure sensor (high)
S*NPL	Pressure sensor (low)
S*PH, HPS*	Pressure switch (high)
S*PL	Pressure switch (low)
S*T	Thermostat
S*RH	Humidity sensor
S*W, SW*	Operation switch
SA*, F1S	Surge arrester
SR*, WLU	Signal receiver
SS*	Selector switch
SHEET METAL	Terminal strip fixed plate
T*R	Transformer
TC, TRC	Transmitter
V*, R*V	Varistor
V*R	Diode bridge, Insulated-gate bipolar transistor (IGBT) power module
WRC	Wireless remote controller
X*	Terminal
X*M	Terminal strip (block)
Y*E	Electronic expansion valve coil
Y*R, Y*S	Reversing solenoid valve coil
Z*C	Ferrite core
ZF, Z*F	Noise filter

25 Glossary

Dealer

Sales distributor for the product.

Authorised installer

Technical skilled person who is qualified to install the product.

User

Person who is owner of the product and/or operates the product.

Applicable legislation

All international, European, national and local directives, laws, regulations and/or codes that are relevant and applicable for a certain product or domain.

Service company

Qualified company which can perform or coordinate the required service to the product.

Installation manual

Instruction manual specified for a certain product or application, explaining how to install, configure and maintain it.

Operation manual

Instruction manual specified for a certain product or application, explaining how to operate it.

Accessories

Labels, manuals, information sheets and equipment that are delivered with the product and that need to be installed according to the instructions in the accompanying documentation.

Optional equipment

Equipment made or approved by Daikin that can be combined with the product according to the instructions in the accompanying documentation.

Field supply

Equipment NOT made by Daikin that can be combined with the product according to the instructions in the accompanying documentation.

ERC