



Installation manual

Daikin room air conditioner



FTXF20F5V1B
FTXF25F5V1B
FTXF35F5V1B
FTXF42F5V1B

Installation manual
Daikin room air conditioner

English

Table of contents

1	About the documentation	2
1.1	About this document.....	2
2	Specific installer safety instructions	2
3	About the box	4
3.1	Indoor unit.....	4
3.1.1	To remove the accessories from the indoor unit.....	4
4	About the unit	4
4.1	System layout.....	4
4.2	Operation range.....	5
4.3	About the wireless LAN.....	5
4.3.1	Precautions when using the wireless LAN.....	5
4.3.2	Basic parameters.....	5
5	Unit installation	5
5.1	Preparing the installation site.....	5
5.1.1	Installation site requirements of the indoor unit.....	5
5.1.2	Additional installation site requirements of the outdoor unit in cold climates.....	5
5.2	Opening the indoor unit.....	5
5.2.1	To remove the front panel.....	5
5.2.2	To re-install the front panel.....	6
5.2.3	To remove the front grille.....	6
5.2.4	To re-install the front grille.....	6
5.2.5	To remove the electrical wiring box cover.....	6
5.2.6	To open the service cover.....	6
5.3	Mounting the indoor unit.....	7
5.3.1	To install the mounting plate.....	7
5.3.2	To drill a wall hole.....	7
5.3.3	To remove the pipe port cover.....	7
5.3.4	To provide drainage.....	8
6	Piping installation	9
6.1	Preparing refrigerant piping.....	9
6.1.1	Refrigerant piping requirements.....	9
6.1.2	Refrigerant piping insulation.....	9
6.2	Connecting the refrigerant piping.....	9
6.2.1	Guidelines when connecting the refrigerant piping.....	9
6.2.2	To connect the refrigerant piping to the indoor unit.....	10
6.3	Checking the refrigerant piping.....	10
6.3.1	To check for leaks.....	10
6.3.2	To perform vacuum drying.....	10
7	Electrical installation	10
7.1	Specifications of standard wiring components.....	11
7.2	To connect the electrical wiring to the indoor unit.....	11
8	Finishing the indoor unit installation	11
8.1	To insulate the drain piping, refrigerant piping and interconnection cable.....	11
8.2	To pass the pipes through the wall hole.....	11
8.3	To fix the unit on the mounting plate.....	12
9	Configuration	12
9.1	To set a different channel of the indoor unit infrared signal receiver.....	12
10	Commissioning	13
10.1	Checklist before commissioning.....	13
10.2	To perform a test run.....	13
10.2.1	To perform a test run in winter season.....	13
11	Disposal	13
12	Technical data	14
12.1	Wiring diagram.....	14
12.1.1	Unified wiring diagram legend.....	14

1 About the documentation

1.1 About this document



INFORMATION

Make sure that the user has the printed documentation and ask him/her to keep it for future reference.

Target audience

Authorised installers



INFORMATION

This appliance is intended to be used by expert or trained users in shops, in light industry, and on farms, or for commercial and household use by lay persons.

Documentation set

This document is part of a documentation set. The complete set consists of:

- **General safety precautions:**
 - Safety instructions that you **MUST** read before installing
 - Format: Paper (in the box of the indoor unit)
- **Indoor unit installation manual:**
 - Installation instructions
 - Format: Paper (in the box of the indoor unit)
- **Installer reference guide:**
 - Preparation of the installation, good practices, reference data,...
 - Format: Digital files on <https://www.daikin.eu>. Use the search function 🔍 to find your model.

The latest revision of the supplied documentation is published on the regional Daikin website and is available via your dealer.

The original instructions are written in English. All other languages are translations of the original instructions.

Technical engineering data

- A **subset** of the latest technical data is available on the regional Daikin website (publicly accessible).
- The **full set** of the latest technical data is available on the Daikin Business Portal (authentication required).

2 Specific installer safety instructions

Always observe the following safety instructions and regulations.

Unit installation (see "5 Unit installation" [▶ 5])



WARNING

Installation shall be done by an installer, the choice of materials and installation shall comply with the applicable legislation. In Europe, EN378 is the applicable standard.

Installation site (see "5.1 Preparing the installation site" [▶ 5])



CAUTION

- Check if the installation location can support the unit's weight. Poor installation is hazardous. It can also cause vibrations or unusual operating noise.
- Provide sufficient service space.
- Do **NOT** install the unit so that it is in contact with a ceiling or a wall, as this may cause vibrations.

 **WARNING**

The appliance shall be stored in a room without continuously operating ignition sources (example: open flames, an operating gas appliance or an operating electric heater).

Connecting the refrigerant piping (see "6.2 Connecting the refrigerant piping" [p 9])

 **CAUTION**

- No brazing or welding on site for units with R32 refrigerant charge during shipment.
- During installation of the refrigeration system, joining of parts with at least one part charged shall be performed taking into account the following requirements: inside occupied spaces non-permanent joints are NOT allowed for R32 refrigerant except for site made joints directly connecting the indoor unit to piping. Site made joints directly connecting piping to indoor units shall be of non-permanent type.

 **NOTICE**

- Use the flare nut fixed to the unit.
- To prevent gas leakage, apply refrigeration oil ONLY to the inside of the flare. Use refrigeration oil for R32 (FW68DA).
- Do NOT reuse joints.

 **NOTICE**

- Do NOT use mineral oil on flared part.
- Do NOT reuse piping from previous installations.
- NEVER install a drier to this R32 unit to guarantee its lifetime. The drying material may dissolve and damage the system.

 **WARNING**

Connect the refrigerant piping securely before running the compressor. If the refrigerant piping is NOT connected and the stop valve is open when the compressor is run, air will be sucked in. This will cause abnormal pressure in the refrigeration cycle, which may result in equipment damage and even injury.

 **CAUTION**

- Incomplete flaring may cause refrigerant gas leakage.
- Do NOT re-use flares. Use new flares to prevent refrigerant gas leakage.
- Use flare nuts that are included with the unit. Using different flare nuts may cause refrigerant gas leakage.

 **CAUTION**

Do NOT open the valves before flaring is complete. This would cause refrigerant gas leakage.

 **DANGER: RISK OF EXPLOSION**

Do NOT open the stop valves before the vacuum drying is finished.

Charging refrigerant (see Charging refrigerant)

 **WARNING**

- The refrigerant inside the unit is mildly flammable, but normally does NOT leak. If the refrigerant leaks in the room and comes in contact with fire from a burner, a heater, or a cooker, this may result in fire, or the formation of a harmful gas.
- Turn OFF any combustible heating devices, ventilate the room, and contact the dealer where you purchased the unit.
- Do NOT use the unit until a service person confirms that the part from which the refrigerant leaked has been repaired.

 **WARNING**

- Only use R32 as refrigerant. Other substances may cause explosions and accidents.
- R32 contains fluorinated greenhouse gases. Its global warming potential (GWP) value is 675. Do NOT vent these gases into the atmosphere.
- When charging refrigerant, ALWAYS use protective gloves and safety glasses.

 **NOTICE**

To avoid compressor breakdown, do NOT charge more than the specified amount of refrigerant.

 **WARNING**

NEVER directly touch any accidental leaking refrigerant. This could result in severe wounds caused by frostbite.

Electrical installation (see "7 Electrical installation" [p 10])

 **WARNING**

The appliance MUST be installed in accordance with national wiring regulations.

 **WARNING**

- All wiring MUST be performed by an authorised electrician and MUST comply with the national wiring regulation.
- Make electrical connections to the fixed wiring.
- All components procured on-site and all electrical construction MUST comply with the applicable legislation.

 **WARNING**

- If the power supply has a missing or wrong N-phase, equipment might break down.
- Establish proper earthing. Do NOT earth the unit to a utility pipe, surge absorber, or telephone earth. Incomplete earthing may cause electrical shocks.
- Install the required fuses or circuit breakers.
- Secure the electrical wiring with cable ties so that the cables do NOT come in contact with sharp edges or piping, particularly on the high-pressure side.
- Do NOT use taped wires, extension cords, or connections from a star system. They can cause overheating, electrical shocks or fire.
- Do NOT install a phase advancing capacitor, because this unit is equipped with an inverter. A phase advancing capacitor will reduce performance and may cause accidents.

 **WARNING**

ALWAYS use multicore cable for power supply cables.

3 About the box



WARNING

Use an all-pole disconnection type breaker with at least 3 mm between the contact point gaps that provides full disconnection under overvoltage category III.



WARNING

If the supply cord is damaged, it **MUST** be replaced by the manufacturer, its service agent or similarly qualified persons in order to avoid a hazard.



WARNING

Do **NOT** connect the power supply to the indoor unit. This could result in electrical shock or fire.



WARNING

- Do **NOT** use locally purchased electrical parts inside the product.
- Do **NOT** branch the power supply for the drain pump, etc. from the terminal block. This could result in electrical shock or fire.



WARNING

Keep the interconnection wiring away from copper pipes without thermal insulation as such pipes will be very hot.



DANGER: RISK OF ELECTROCUTION

All electrical parts (including thermistors) are powered by the power supply. Do **NOT** touch them with bare hands.



DANGER: RISK OF ELECTROCUTION

Disconnect the power supply for more than 10 minutes, and measure the voltage at the terminals of main circuit capacitors or electrical components before servicing. The voltage **MUST** be less than 50 V DC before you can touch electrical components. For the location of the terminals, see the wiring diagram.

Finishing indoor unit installation (see **Finishing the outdoor unit installation**)



DANGER: RISK OF ELECTROCUTION

- Make sure that the system is earthed properly.
- Turn **OFF** the power supply before servicing.
- Install the switch box cover before turning **ON** the power supply.

Commissioning (see **"10 Commissioning"** [▶ 13])



DANGER: RISK OF ELECTROCUTION



DANGER: RISK OF BURNING/SCALDING



CAUTION

Do **NOT** perform the test operation while working on the indoor unit(s).

When performing the test operation, **NOT ONLY** the outdoor unit, but the connected indoor unit will operate as well. Working on an indoor unit while performing a test operation is dangerous.



CAUTION

Do **NOT** insert fingers, rods or other objects into the air inlet or outlet. Do **NOT** remove the fan guard. When the fan is rotating at high speed, it will cause injury.



A2L WARNING: MILDLY FLAMMABLE MATERIAL

The refrigerant inside this unit is mildly flammable.

3 About the box

3.1 Indoor unit



INFORMATION

The following figures are examples and may **NOT** completely match your system layout.

3.1.1 To remove the accessories from the indoor unit

1 Remove:

- the accessory bag located at the bottom of the package,
- the mounting plate attached to the back of the indoor unit.
- the spare SSID sticker located on the front grille.

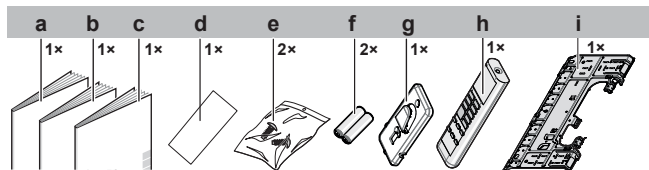

- a Installation manual
- b Operation manual
- c General safety precautions
- d Spare SSID sticker
- e Indoor unit fixing screw (M4×12L). Refer to **"8.3 To fix the unit on the mounting plate"** [▶ 12].
- f Dry battery AAA.LR03 (alkaline) for user interface
- g Holder for wireless remote control (user interface)r
- h Wireless remote control (user interface)
- i Mounting plate

- 2 **Spare SSID sticker.** Do **NOT** throw away the spare sticker. Keep it in a safe place in case it is needed in future (e.g. in case the front grille was replaced attach it to the new front grille).

4 About the unit



A2L WARNING: MILDLY FLAMMABLE MATERIAL

The refrigerant inside this unit is mildly flammable.

4.1 System layout



INFORMATION

The following figures are examples and may **NOT** completely match your system layout.

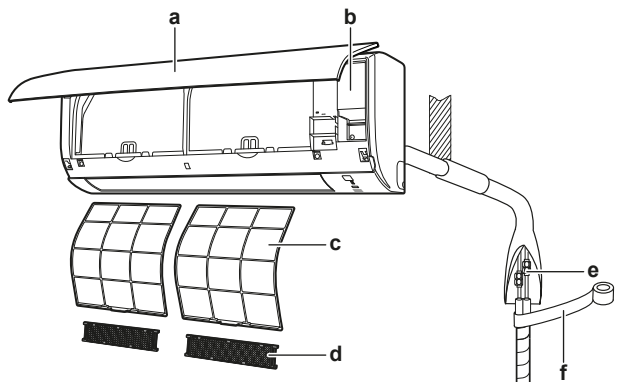

- a Indoor unit
- b Service lid
- c Air filter
- d Titanium apatite deodorizing and silver particle filter
- e Refrigerant piping, drain hose and interconnection cable
- f Insulation tape

4.2 Operation range

Use the system in the following temperature and humidity ranges for safe and effective operation.

Operation mode	Operation range
Cooling ^{(a)(b)}	<ul style="list-style-type: none"> Outdoor temperature: -10~48°C DB Indoor temperature: 18~32°C DB Indoor humidity: ≤80%
Heating ^(a)	<ul style="list-style-type: none"> Outdoor temperature: -15~24°C DB Indoor temperature: 10~30°C DB
Drying ^(a)	<ul style="list-style-type: none"> Outdoor temperature: -10~48°C DB Indoor temperature: 18~32°C DB Indoor humidity: ≤80%

^(a) A safety device might stop the operation of the system if the unit runs outside its operation range.

^(b) Condensation and water dripping might occur if the unit runs outside its operation range.

4.3 About the wireless LAN

For detailed specifications, installation instructions, setting methods, FAQ, declaration of conformity and the latest version of this manual, visit app.daikineurope.com.



INFORMATION: Declaration of conformity

- Daikin Europe N. V. declares that the radio equipment type inside of this unit is in compliance with Directive 2014/53/EU and S.I. 2017/1206: Radio Equipment Regulations 2017.
- This unit is considered as combined equipment according to the definition of Directive 2014/53/EU and S.I. 2017/1206: Radio Equipment Regulations 2017.

4.3.1 Precautions when using the wireless LAN

Do NOT use near:

- Medical equipment.** E.g. persons using cardiac pacemakers or defibrillators. This product may cause electromagnetic interference.
- Auto-control equipment.** E.g. automatic doors or fire alarm equipment. This product may cause faulty behaviour of the equipment.
- Microwave oven.** It may affect wireless LAN communications.

4.3.2 Basic parameters

What	Value
Frequency range	2400 MHz~2483.5 MHz
Radio protocol	IEEE 802.11b/g/n
Radio frequency channel	1~13
Output power	13 dBm
Effective radiated power	15 dBm (11b) / 14 dBm (11g) / 14 dBm (11n)
Power supply	DC 14 V / 100 mA

5 Unit installation

5.1 Preparing the installation site



WARNING

The appliance shall be stored in a room without continuously operating ignition sources (example: open flames, an operating gas appliance or an operating electric heater).



WARNING

The appliance using R32 refrigerant shall be stored so as to prevent mechanical damage and in a well-ventilated room without continuously operating ignition sources (e.g. open flames, an operating gas appliance, or an operating electric heater). The room size shall be as specified in the General safety precaution.

5.1.1 Installation site requirements of the indoor unit



INFORMATION

The sound pressure level is less than 70 dBA.

- Air flow.** Make sure nothing blocks the air flow.
- Drainage.** Make sure condensation water can be evacuated properly.
- Wall insulation.** When conditions in the wall exceed 30°C and a relative humidity of 80%, or when fresh air is inducted into the wall, then additional insulation is required (minimum 10 mm thickness, polyethylene foam).
- Wall strength.** Check whether the wall or the floor is strong enough to support the weight of the unit. If there is a risk, reinforce the wall or the floor before installing the unit.
- Spacing.** Install the unit at least 1.8 m from the floor and keep the following requirements in mind for distances from the walls and the ceiling:

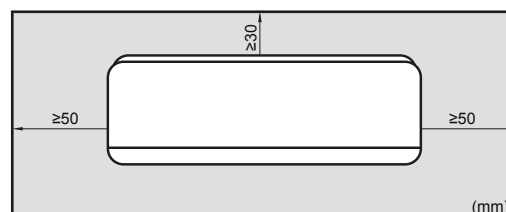

5.1.2 Additional installation site requirements of the outdoor unit in cold climates

Protect the outdoor unit against direct snowfall and take care that the outdoor unit is NEVER snowed up.

In heavy snowfall areas it is very important to select an installation site where the snow will NOT affect the unit. If lateral snowfall is possible, make sure that the heat exchanger coil is NOT affected by the snow. If necessary, install a snow cover or shed and a pedestal.

5.2 Opening the indoor unit

5.2.1 To remove the front panel

- 1 Hold the front panel by the panel tabs on both sides and open it.

5 Unit installation

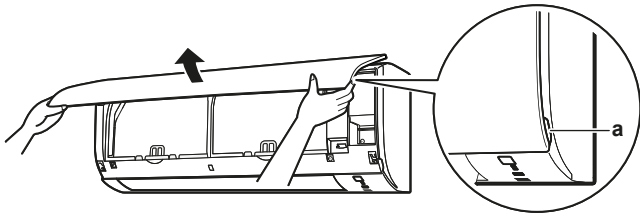

a Panel tabs

- 2 Remove the front panel by sliding it to the left or the right and pulling it toward you.

Result: The front panel shaft on 1 side will be disconnected.

- 3 Disconnect the front panel shaft on the other side in the same manner.

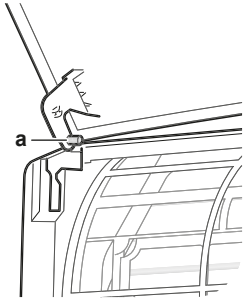

a Front panel shaft

5.2.2 To re-install the front panel

- 1 Attach the front panel. Align the shafts with the slots and push them all the way in.
- 2 Close the front panel slowly; press at both sides and at the centre.

5.2.3 To remove the front grille



CAUTION

Wear adequate personal protective equipment (protective gloves, safety glasses,...) when installing, maintaining or servicing the system.

- 1 Remove the front panel to remove the air filter.
- 2 Remove 2 screws (class 20~35) or 3 screws (class 50~71) from the front grille.
- 3 Push down the 3 upper hooks marked with a symbol with 3 circles.

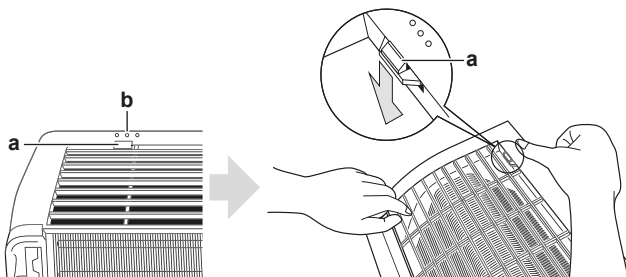

a Upper hook
b Symbol with 3 circles

- 4 We recommend opening the flap before removing the front grille.
- 5 Place both hands under the centre of the front grille, push it up and then toward you.

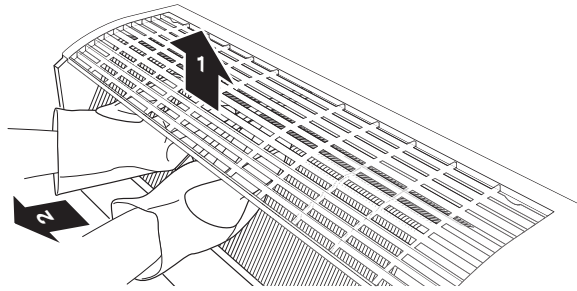

5.2.4 To re-install the front grille

- 1 Install the front grille and firmly engage the 3 upper hooks.
- 2 Install 2 screws back on the front grille.
- 3 Install the air filter and then mount the front panel.

5.2.5 To remove the electrical wiring box cover

Prerequisite: Remove the front grille.

- 1 Remove 1 screw from the electrical wiring box.
- 2 Open the electrical wiring box cover by pulling the protruding part on the top of the cover.
- 3 Unhook the tab on the bottom and remove the electrical wiring box cover.

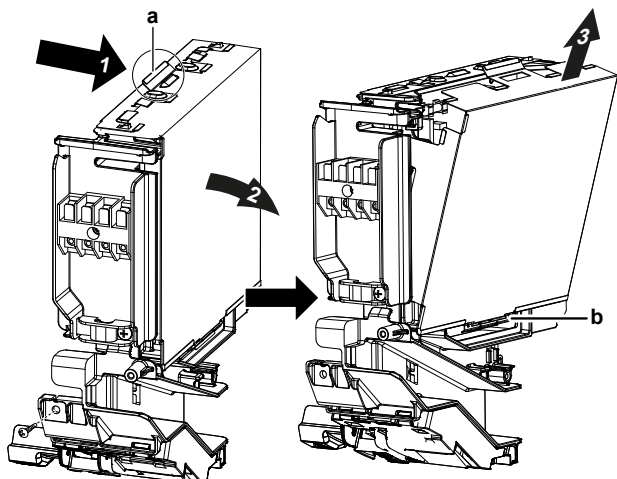

a Protruding part on the top of the cover
b Tab

5.2.6 To open the service cover

- 1 Remove 1 screw from the service cover.
- 2 Pull out the service cover horizontally away from the unit.

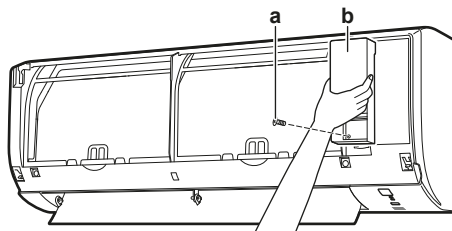

a Service cover screw
b Service cover

5.3 Mounting the indoor unit

5.3.1 To install the mounting plate

- 1 Install the mounting plate temporarily.
- 2 Level the mounting plate.
- 3 Mark the centres of the drilling points on the wall using a tape measure. Position the end of tape measure at symbol ">".
- 4 Finish the installation by securing the mounting plate on the wall using M4×25L screws (field supply).

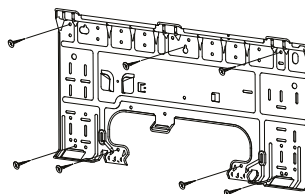

INFORMATION

The removed pipe port cover can be kept in the mounting plate pocket.

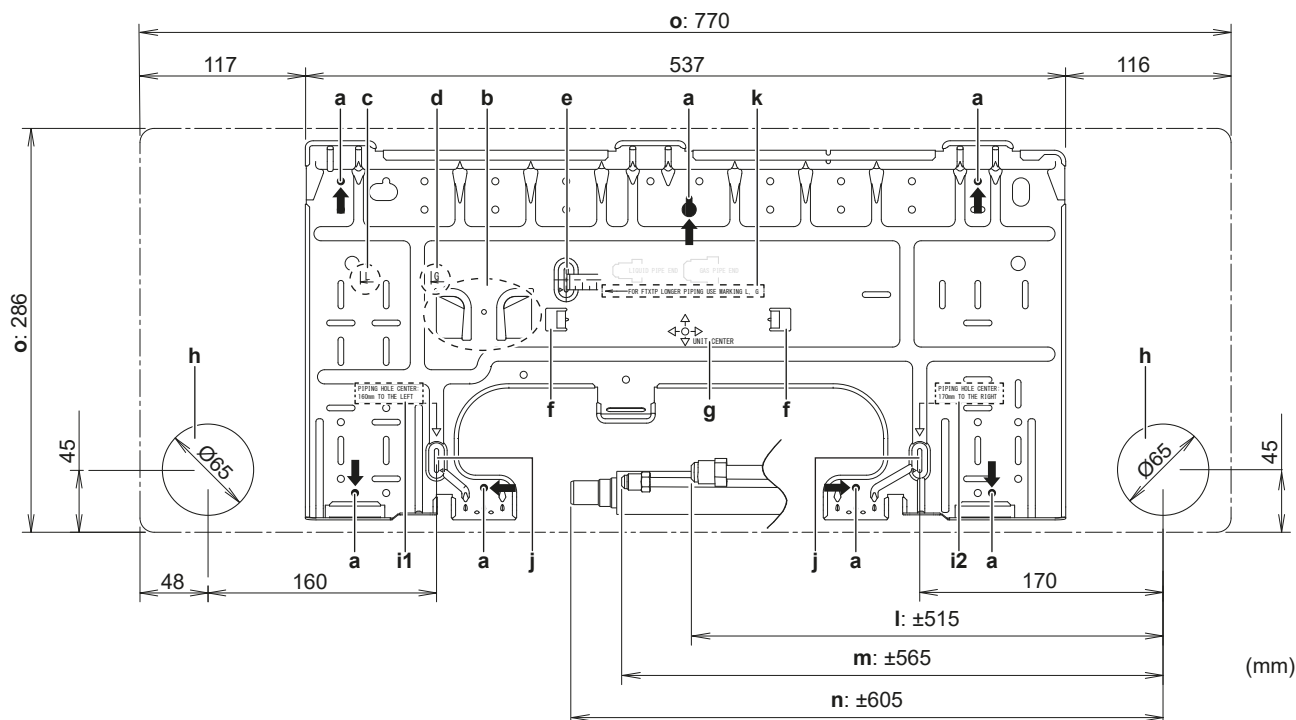

- a Recommended mounting plate fixing spots
- b Pocket for the pipe port cover
- c Liquid pipe end
- d Gas pipe end
- e Use tape measure as shown
- f Tabs for placing a spirit level
- g Unit center
- h Hole for embedded piping $\varnothing 65$ mm

- i1 Piping hole center: 160 mm to the left
- i2 Piping hole center: 170 mm to the right
- j Position for tape measure at symbol ">"
- k For FTXTP pipe end use marking "L" and "G"
- l Gas pipe length
- m Liquid pipe length
- n Drain hose length
- o Outline of the unit

5.3.2 To drill a wall hole



CAUTION

For walls containing a metal frame or a metal board, use a wall embedded pipe and wall cover in the feed-through hole to prevent possible heat, electrical shock, or fire.



NOTICE

Be sure to seal the gaps around the pipes with sealing material (field supply), in order to prevent water leakage.

- 1 Bore a 65 mm large feed-through hole in the wall with a downward slope towards the outside.
- 2 Insert a wall embedded pipe into the hole.
- 3 Insert a wall cover into the wall pipe.

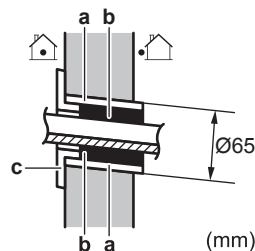

- a Wall embedded pipe
- b Putty
- c Wall hole cover

- 4 After completing wiring, refrigerant piping and drain piping, do NOT forget to seal the gap with putty.

5.3.3 To remove the pipe port cover



INFORMATION

To connect the piping on right-side, right-bottom, left-side or left-bottom, the pipe port cover MUST be removed.

- 1 Cut off the pipe port cover from inside the front grille using a coping saw.

5 Unit installation

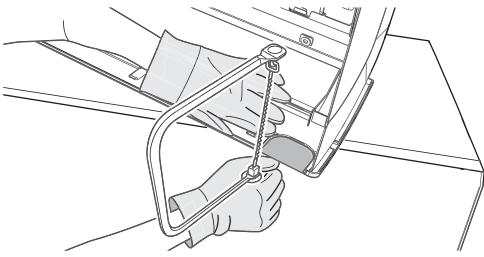

- 2 Remove any burrs along the cut section using a half round needle file.

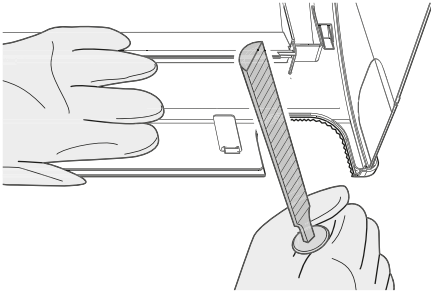

NOTICE

Do NOT use nippers to remove the pipe port cover, as this would damage the front grille.

5.3.4 To provide drainage

Make sure condensation water can be evacuated properly. This involves:

- General guidelines
- Connecting the drain piping to the indoor unit
- Checking for water leaks

General guidelines

- **Pipe length.** Keep drain piping as short as possible.
- **Pipe size.** If drain hose extension or embedded drain piping is required, use appropriate parts that match the hose front end.

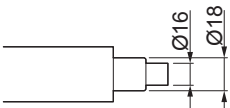

NOTICE

- Install the drain hose with a downward slope.
- Traps are NOT permitted.
- Do NOT put the end of the hose in water.

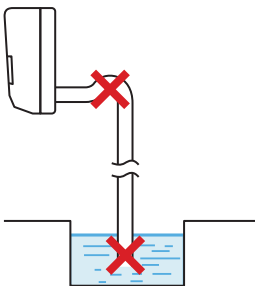

- **Drain hose extension.** To extend the drain hose, use a field supplied hose with inner Ø16 mm. Do NOT forget to use a heat insulation tube on the indoor section of the extension hose.

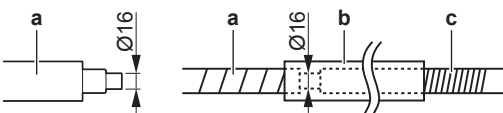

a Drain hose supplied with the indoor unit

- b Heat insulation tube (field supply)
- c Extension drain hose

- **Rigid polyvinyl chloride pipe.** When connecting a rigid polyvinyl chloride pipe (nominal Ø13 mm) directly to the drain hose as with embedded piping work, use a field supplied drain socket (nominal Ø13 mm).

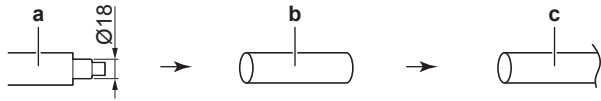

- a Drain hose supplied with the indoor unit
- b Drain socket with nominal Ø13 mm (field supply)
- c Rigid polyvinyl chloride pipe (field supply)

- **Condensation.** Take measures against condensation. Insulate the complete drain piping in the building.

- 1 Insert the drain hose in the drain pipe as shown in the following figure, so it will NOT be pulled out of the drain pipe.

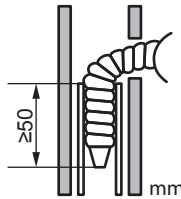

To connect the piping on right side, right-back, or right-bottom

INFORMATION

The factory default is right-side piping. For left-side piping, remove the piping from the right side and install it on the left side.

- 1 Attach the drain hose with adhesive vinyl tape to the bottom of the refrigerant pipes.
- 2 Wrap the drain hose and the refrigerant pipes together using insulation tape.

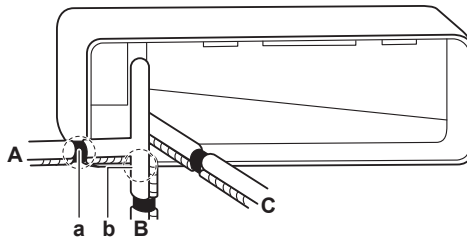

- A Right-side piping
- B Right-bottom piping
- C Right-back piping
- a Remove the pipe port cover here for right side piping
- b Remove the pipe port cover here for right-bottom piping

To connect the piping on left side, left-back, or left-bottom

INFORMATION

The factory default is right-side piping. For left-side piping, remove the piping from the right side and install it on the left side.

- 1 Remove the insulation fixing screw on the right side and remove the drain hose.
- 2 Remove the drain plug on the left side and attach it to the right side.

NOTICE

Do NOT apply lubricating oil (refrigerant oil) to the drain plug when inserting it. The drain plug may deteriorate and cause drain leakage from the plug.

- 3 Insert the drain hose on the left side and do not forget to tighten it with the fixing screw; otherwise water leakage may occur.

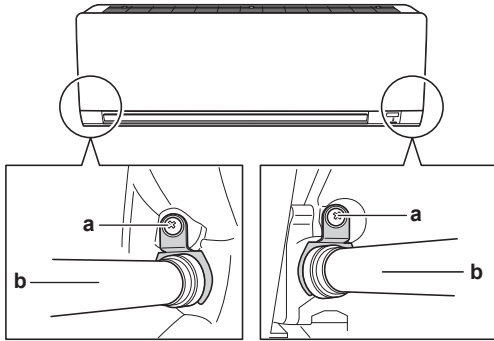

a Insulation fixing screw
b Drain hose

- 4 Attach the drain hose to the refrigerant piping bottom side using adhesive vinyl tape.

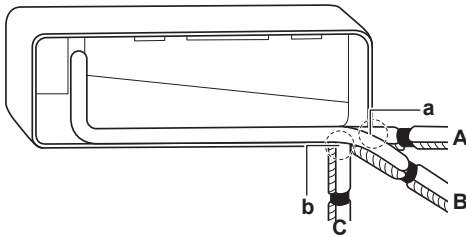

A Left-side piping
B Left-back piping
C Left-bottom piping
a Remove the pipe port cover here for left-side piping
b Remove the pipe port cover here for left-bottom piping

To check for water leaks

- 1 Remove the air filters.
- 2 Gradually pour approximately 1 l of water in the drain pan, and check for water leaks.

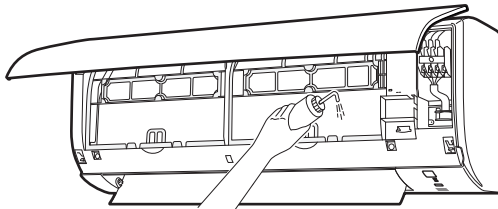

6 Piping installation

6.1 Preparing refrigerant piping

6.1.1 Refrigerant piping requirements



NOTICE

The piping and other pressure-containing parts shall be suitable for refrigerant. Use phosphoric acid deoxidised seamless copper for refrigerant piping.

- Foreign materials inside pipes (including oils for fabrication) must be ≤ 30 mg/10 m.

Refrigerant piping diameter

Use the same diameters as the connections on the outdoor units:

Pipe outer diameter (mm)	
Liquid piping	Gas piping
Ø6.4 (1/4")	Ø9.5 (3/8")

Refrigerant piping material

Piping material

Phosphoric acid deoxidised seamless copper

Flare connections

Only use annealed material.

Piping temper grade and thickness

Outer diameter (Ø)	Temper grade	Thickness (t) ^(a)	
6.4 mm (1/4")	Annealed (O)	≥ 0.8 mm	

^(a) Depending on the applicable legislation and the maximum working pressure of the unit (see "PS High" on the unit name plate), larger piping thickness might be required.

6.1.2 Refrigerant piping insulation

- Use polyethylene foam as insulation material:
 - with a heat transfer rate between 0.041 and 0.052 W/mK (0.035 and 0.045 kcal/mh°C)
 - with a heat resistance of at least 120°C
- Insulation thickness:

Pipe outer diameter (Ø _p)	Insulation inner diameter (Ø _i)	Insulation thickness (t)
6.4 mm (1/4")	8~10 mm	≥ 10 mm

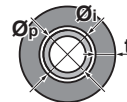

If the temperature is higher than 30°C and the humidity is higher than RH 80%, the thickness of the insulation materials should be at least 20 mm to prevent condensation on the surface of the insulation.

6.2 Connecting the refrigerant piping



DANGER: RISK OF BURNING/SCALDING

6.2.1 Guidelines when connecting the refrigerant piping

Take the following guidelines into account when connecting pipes:

- Coat the flare inner surface with ether oil or ester oil when connecting a flare nut. Tighten 3 or 4 turns by hand, before tightening firmly.

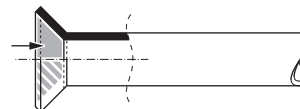

- ALWAYS use 2 wrenches together when loosening a flare nut.
- ALWAYS use a spanner and torque wrench together to tighten the flare nut when connecting the piping. This to prevent nut cracking and leaks.

7 Electrical installation

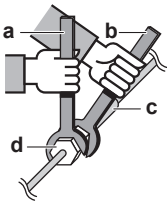

- a Torque wrench
- b Spanner
- c Piping union
- d Flare nut

Piping size (mm)	Tightening torque (N·m)	Flare dimensions (A) (mm)	Flare shape (mm)
Ø6.4	15~17	8.7~9.1	
Ø9.5	33~39	12.8~13.2	

6.2.2 To connect the refrigerant piping to the indoor unit



WARNING: MILDLY FLAMMABLE MATERIAL

The refrigerant inside this unit is mildly flammable.

- **Pipe length.** Keep refrigerant piping as short as possible.

- 1 Connect refrigerant piping to the unit using **flare connections**.
- 2 **Insulate** the refrigerant piping, interconnection cable and drain hose on the indoor unit as follows:

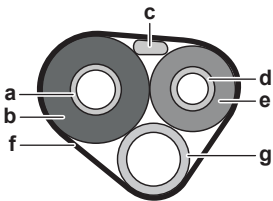

- a Gas pipe
- b Gas pipe insulation
- c Interconnection cable
- d Liquid pipe
- e Liquid pipe insulation
- f Finishing tape
- g Drain hose



NOTICE

Make sure to insulate all refrigerant piping. Any exposed piping might cause condensation.

6.3 Checking the refrigerant piping

6.3.1 To check for leaks



NOTICE

Do NOT exceed the unit's maximum working pressure (see "PS High" on the unit name plate).



NOTICE

ALWAYS use a recommended bubble test solution from your wholesaler.

NEVER use soap water:

- Soap water may cause cracking of components, such as flare nuts or stop valve caps.
- Soap water may contain salt, which absorbs moisture that will freeze when the piping gets cold.
- Soap water contains ammonia which may lead to corrosion of flared joints (between the brass flare nut and the copper flare).

- 1 Charge the system with nitrogen gas up to a gauge pressure of at least 200 kPa (2 bar). It is recommended to pressurize to 3000 kPa (30 bar) or higher (depending on local legislation) to detect small leaks.
- 2 Check for leaks by applying the bubble test solution to all connections.
- 3 Discharge all nitrogen gas.

6.3.2 To perform vacuum drying

- 1 Vacuum the system until the pressure on the manifold indicates -0.1 MPa (-1 bar).
- 2 Leave as is for 4-5 minutes and check the pressure:

If the pressure...	Then...
Does not change	There is no moisture in the system. This procedure is finished.
Increases	There is moisture in the system. Go to the next step.

- 3 Vacuum the system for at least 2 hours to a manifold pressure of -0.1 MPa (-1 bar).
- 4 After turning the pump OFF, check the pressure for at least 1 hour.
- 5 If you do NOT reach the target vacuum or CANNOT maintain the vacuum for 1 hour, do the following:
 - Check for leaks again.
 - Perform vacuum drying again.

7 Electrical installation



DANGER: RISK OF ELECTROCUTION



WARNING

ALWAYS use multicore cable for power supply cables.



WARNING

Use an all-pole disconnection type breaker with at least 3 mm between the contact point gaps that provides full disconnection under overvoltage category III.



WARNING

If the supply cord is damaged, it MUST be replaced by the manufacturer, its service agent or similarly qualified persons in order to avoid a hazard.



WARNING

Do NOT connect the power supply to the indoor unit. This could result in electrical shock or fire.



WARNING

- Do NOT use locally purchased electrical parts inside the product.
- Do NOT branch the power supply for the drain pump, etc. from the terminal block. This could result in electrical shock or fire.



WARNING

Keep the interconnection wiring away from copper pipes without thermal insulation as such pipes will be very hot.

7.1 Specifications of standard wiring components



NOTICE

We recommend using solid wires. If stranded wires are used, slightly twist the strands to consolidate the end of the conductor for either direct use in the terminal clamp or insertion in a round crimp-style terminal. Details are described in "Guidelines when connecting the electrical wiring" in the installer reference guide.

Specifications	
Voltage	220~240 V
Phase	1~
Frequency	50 Hz
Interconnection cable	Only use harmonised wire providing double insulation and suitable for the applicable voltage. 4-core cable Minimum 1.5 mm ²

7.2 To connect the electrical wiring to the indoor unit



WARNING

Provide adequate measures to prevent that the unit can be used as a shelter by small animals. Small animals that make contact with electrical parts can cause malfunctions, smoke or fire.



NOTICE

- Keep power supply wiring and interconnection wiring apart from each other. Interconnection wiring and power supply wiring may cross, but may NOT run parallel.
- In order to avoid any electrical interference, the distance between both wirings should ALWAYS be at least 50 mm.

Electrical work should be carried out in accordance with the installation manual and the national electrical wiring rules or code of practice.

- Set the indoor unit on the mounting plate hooks. Use the "△" marks as a guide.

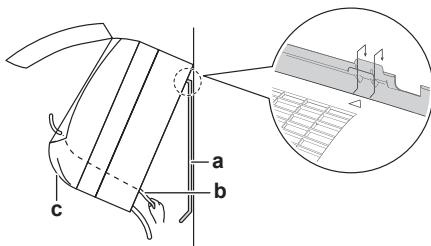

- a Mounting plate (accessory)
- b Interconnection cable
- c Wire guide

- Open the front panel, and then the service cover. Refer to "5.2 Opening the indoor unit" ▶ 5].
- Pass the interconnection cable from the outdoor unit through the feed-through wall hole, through the back of the indoor unit and through the front side.

Note: In case the interconnection cable was stripped in advance, cover the ends with insulating tape.

- Bend the end of the cable up.

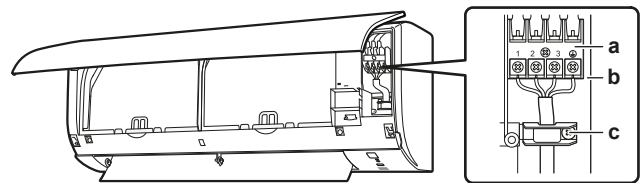

- a Terminal block
- b Electrical component block
- c Cable clamp

- Strip the wire ends approximately 15 mm.
- Match wire colours with terminal numbers on the indoor unit terminal blocks and firmly screw the wires to the corresponding terminals.
- Connect the earth wire to the corresponding terminal.
- Firmly fix the wires with the terminal screws.
- Pull the wires to make sure that they are securely attached, then retain the wires with the wire retainer.
- Shape the wires so that the service cover fits securely, then close the service cover.

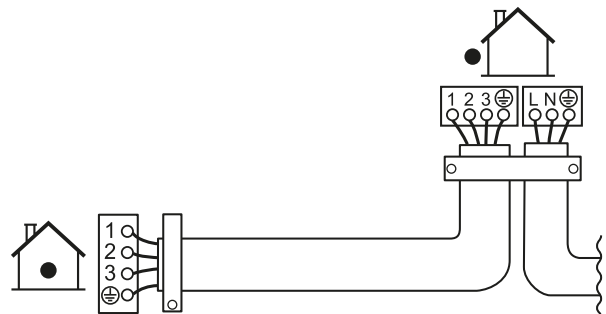

8 Finishing the indoor unit installation

8.1 To insulate the drain piping, refrigerant piping and interconnection cable

- After the drain piping, refrigerant piping and the electrical wiring are finished, wrap refrigerant piping, interconnection cable and drain hose together using insulation tape. Overlap at least half the width of the tape with each turn.

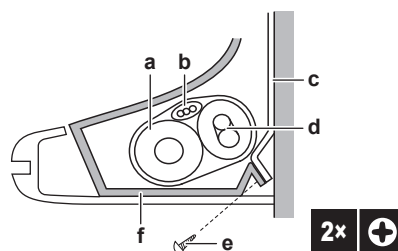

- a Drain hose
- b Interconnection cable
- c Mounting plate (accessory)
- d Refrigerant piping
- e Indoor unit fixing screw M4×12L (accessory)
- f Bottom frame

8.2 To pass the pipes through the wall hole

- Shape the refrigerant pipes along the pipe path marking on the mounting plate.

9 Configuration

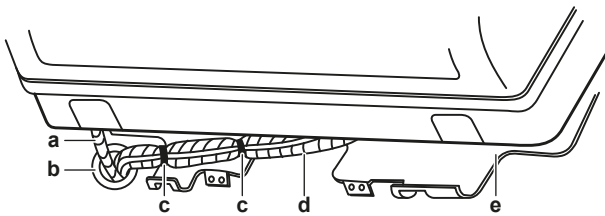

- a Drain hose
- b Caulk this hole with putty or caulking material
- c Adhesive vinyl tape
- d Insulation tape
- e Mounting plate (accessory)

NOTICE

- Do NOT bend refrigerant pipes.
- Do NOT push the refrigerant pipes onto the bottom frame or the front grille.

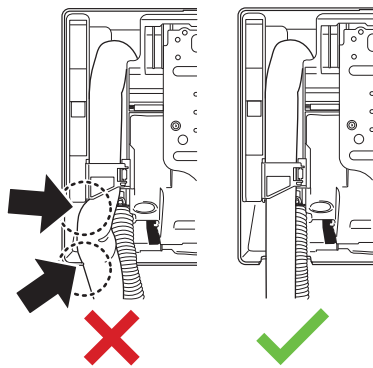

- 2 Pass the drain hose and refrigerant piping through the wall hole and seal the gap with a putty.

8.3 To fix the unit on the mounting plate

- 1 Set the indoor unit on the mounting plate hooks. Use the "△" marks as a guide.

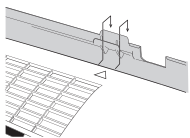

- 2 Press the bottom frame of the unit with both hands to set it on the bottom hooks of the mounting plate. Make sure that the wires do NOT get squeezed anywhere.

Note: Take care that the interconnection cable does NOT get caught in the indoor unit.

- 3 Press the bottom edge of the indoor unit with both hands until it is firmly caught by the mounting plate hooks.
- 4 Secure the indoor unit to the mounting plate using 2 indoor unit fixing screws M4×12L (accessory).

9 Configuration

9.1 To set a different channel of the indoor unit infrared signal receiver

In case 2 indoor units are installed in 1 room, you can change the channel for the infrared signal receiver on the indoor unit to avoid the wireless remote control signal confusion.

Prerequisite: Perform the following setting for only 1 of the units

- 1 Remove the batteries from the user interface.

- 2 Cut the address jumper.

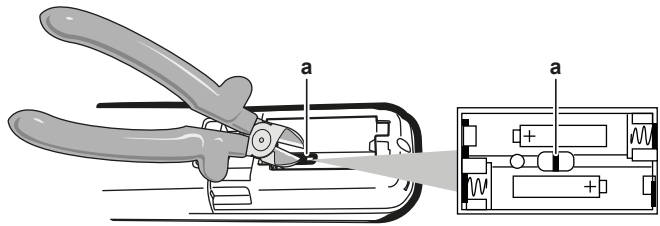

a Address jumper



NOTICE

Be careful NOT to damage any of the surrounding parts when cutting the address jumper.

- 3 Turn the power supply on.

Result: The flap of the indoor unit will open and close to set the reference position.



INFORMATION

In case you could NOT complete the setting in time, turn the power supply off and wait at least 1 minute before turning the power supply back on.

- 4 Press simultaneously:

Model	Buttons
FTXF and ATXF	TEMP ↑, TEMP ↓ and OFF

- 5 Press:

Model	Buttons
FTXF and ATXF	TEMP ↑

- 6 Select:

Model	Symbol
FTXF and ATXF	⌘

- 7 Press:

Model	Button
FTXF and ATXF	FAN

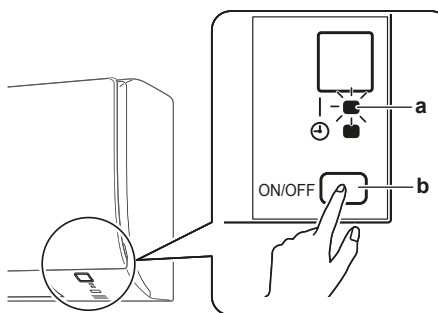

- a Operation lamp
- b Indoor unit ON/OFF switch

- 8 Press the indoor unit ON/OFF switch while the operation lamp is blinking.

Jumper	Address
Factory setting	1
After cutting with nippers	2



INFORMATION

If the setting could NOT be completed while the operation lamp was blinking, repeat the setting process from the beginning.

- 9 When the setting is complete, press:

Model	Button
FTXF and ATXF	Keep  pressed for about 5 seconds.

Result: The user interface will return to the previous screen.

10 Commissioning



NOTICE

ALWAYS operate the unit with thermistors and/or pressure sensors/switches. If NOT, burning of the compressor might be the result.

10.1 Checklist before commissioning

- 1 After the installation of the unit, check the items listed below.
- 2 Close the unit.
- 3 Power up the unit.

<input type="checkbox"/>	You read the complete installation instructions, as described in the installer reference guide .
<input type="checkbox"/>	The indoor units are properly mounted.
<input type="checkbox"/>	The outdoor unit is properly mounted.
<input type="checkbox"/>	Air inlet/outlet Check that the air inlet and outlet of the unit is NOT obstructed by paper sheets, cardboard, or any other material.
<input type="checkbox"/>	There are NO missing phases or reversed phases .
<input type="checkbox"/>	The refrigerant pipes (gas and liquid) are thermally insulated.
<input type="checkbox"/>	Drainage Make sure drainage flows smoothly. Possible consequence: Condensate water might drip.
<input type="checkbox"/>	The system is properly earthed and the earth terminals are tightened.
<input type="checkbox"/>	The fuses or locally installed protection devices are installed according to this document, and have NOT been bypassed.
<input type="checkbox"/>	The power supply voltage matches the voltage on the identification label of the unit.
<input type="checkbox"/>	The specified wires are used for the interconnection cable .
<input type="checkbox"/>	The indoor unit receives the signals of the user interface .
<input type="checkbox"/>	There are NO loose connections or damaged electrical components in the switch box.
<input type="checkbox"/>	The insulation resistance of the compressor is OK.
<input type="checkbox"/>	There are NO damaged components or squeezed pipes on the inside of the indoor and outdoor units.
<input type="checkbox"/>	There are NO refrigerant leaks .
<input type="checkbox"/>	The correct pipe size is installed and the pipes are properly insulated.
<input type="checkbox"/>	The stop valves (gas and liquid) on the outdoor unit are fully open.

10.2 To perform a test run

Prerequisite: The power supply MUST be in the specified range.







Prerequisite: Test run may be performed in cooling or heating mode.

Prerequisite: Refer to the operation manual of the indoor unit for setting temperature, operation mode....

- 1 In cooling mode, select the lowest programmable temperature. In heating mode, select the highest programmable temperature. The test run can be disabled if necessary.
- 2 When the test run is finished, set the temperature to a normal level. In cooling mode: 26~28°C, in heating mode: 20~24°C.
- 3 Make sure that all functions and parts are working properly.
- 4 The system stops operating 3 minutes after the unit is turned OFF.

10.2.1 To perform a test run in winter season

When operating the air conditioner in **Cooling** mode in winter, set it to test run operation using the following method.

- 1 Press , , and  simultaneously.
- 2 Press .
- 3 Select **7**.
- 4 Press .
- 5 Press  to switch the system on.

Result: Test run operation will stop automatically after about 30 minutes.

- 6 To stop operation, press .



INFORMATION

Some of the functions CANNOT be used in the test run operation mode.

If a power failure occurs during operation, the system automatically restarts immediately after power is restored.

11 Disposal



NOTICE

Do NOT try to dismantle the system yourself: dismantling of the system, treatment of the refrigerant, oil and other parts MUST comply with applicable legislation. Units MUST be treated at a specialised treatment facility for reuse, recycling and recovery.

12 Technical data

12 Technical data

- A **subset** of the latest technical data is available on the regional Daikin website (publicly accessible).
- The **full set** of the latest technical data is available on the Daikin Business Portal (authentication required).

12.1 Wiring diagram

The wiring diagram is delivered with the unit, located inside of the outdoor unit (bottom side of the top plate).

12.1.1 Unified wiring diagram legend

For applied parts and numbering, refer to the wiring diagram on the unit. Part numbering is by Arabic numbers in ascending order for each part and is represented in the overview below by "*" in the part code.

Symbol	Meaning	Symbol	Meaning
	Circuit breaker		Protective earth
			Noiseless earth
			Protective earth (screw)
	Connection		Rectifier
	Connector		Relay connector
	Earth		Short-circuit connector
	Field wiring		Terminal
	Fuse		Terminal strip
	Indoor unit		Wire clamp
	Outdoor unit		Heater
	Residual current device		

Symbol	Colour	Symbol	Colour
BLK	Black	ORG	Orange
BLU	Blue	PNK	Pink
BRN	Brown	PRP, PPL	Purple
GRN	Green	RED	Red
GRY	Grey	WHT	White
SKY BLU	Sky blue	YLW	Yellow

Symbol	Meaning
A*P	Printed circuit board
BS*	Pushbutton ON/OFF, operation switch
BZ, H*O	Buzzer
C*	Capacitor
AC*, CN*, E*, HA*, HE*, HL*, HN*, HR*, MR*_A, MR*_B, S*, U, V, W, X*A, K*R_*, NE	Connection, connector
D*, V*D	Diode
DB*	Diode bridge
DS*	DIP switch
E*H	Heater
FU*, F*U, (for characteristics, refer to PCB inside your unit)	Fuse

Symbol	Meaning
FG*	Connector (frame ground)
H*	Harness
H*P, LED*, V*L	Pilot lamp, light emitting diode
HAP	Light emitting diode (service monitor green)
HIGH VOLTAGE	High voltage
IES	Intelligent eye sensor
IPM*	Intelligent power module
K*R, KCR, KFR, KHuR, K*M	Magnetic relay
L	Live
L*	Coil
L*R	Reactor
M*	Stepper motor
M*C	Compressor motor
M*F	Fan motor
M*P	Drain pump motor
MR*, MRCW*, MRM*, MRN*	Magnetic relay
N	Neutral
n=*, N=*	Number of passes through ferrite core
PAM	Pulse-amplitude modulation
PCB*	Printed circuit board
PM*	Power module
PS	Switching power supply
PTC*	PTC thermistor
Q*	Insulated gate bipolar transistor (IGBT)
Q*C	Circuit breaker
Q*DI, KLM	Earth leak circuit breaker
Q*L	Overload protector
Q*M	Thermo switch
Q*R	Residual current device
R*	Resistor
R*T	Thermistor
RC	Receiver
S*C	Limit switch
S*L	Float switch
S*NG	Refrigerant leak detector
S*NPH	Pressure sensor (high)
S*NPL	Pressure sensor (low)
S*PH, HPS*	Pressure switch (high)
S*PL	Pressure switch (low)
S*T	Thermostat
S*RH	Humidity sensor
S*W, SW*	Operation switch
SA*, F1S	Surge arrester
SR*, WLU	Signal receiver
SS*	Selector switch
SHEET METAL	Terminal strip fixed plate
T*R	Transformer
TC, TRC	Transmitter
V*, R*V	Varistor
V*R	Diode bridge, Insulated-gate bipolar transistor (IGBT) power module

Symbol	Meaning
WRC	Wireless remote controller
X*	Terminal
X*M	Terminal strip (block)
Y*E	Electronic expansion valve coil
Y*R, Y*S	Reversing solenoid valve coil
Z*C	Ferrite core
ZF, Z*F	Noise filter

ERC



DAIKIN ISITMA VE SOĞUTMA SİSTEMLERİ SAN. TİC. A.Ş.

Gülsuyu Mahallesi, Fevzi Çakmak Caddesi, Burçak Sokak, No:20, 34848 Maltepe
İSTANBUL / TÜRKİYE
Tel: 0216 453 27 00
Faks: 0216 671 06 00
Çağrı Merkezi: 444 999 0
Web: www.daikin.com.tr

Copyright 2024 Daikin

DAIKIN EUROPE N.V.

Zandvoordestraat 300, B-8400 Oostende, Belgium

3P748643-9M 2025.07