

DAIKIN



OPERATION MANUAL

Air-cooled condensing units

ERAP110MBYNN
ERAP150MBYNN
ERAP170MBYNN

CONTENTS

	Page
Introduction	1
Technical specifications	1
Electrical specifications	1
Important information regarding the refrigerant used	1
Description	2
Function of the main components.....	3
Safety devices.....	3
Internal wiring - Parts table.....	4
Before operation.....	4
Checks before initial start-up.....	4
Power supply connection and crankcase heating.....	5
General recommendations	5
Operation	5
Digital controller.....	5
Working with the unit	6
Advanced features of the digital controller.....	8
Troubleshooting.....	13
Maintenance.....	14
Maintenance activities	14
Disposal requirements.....	14



READ THIS MANUAL ATTENTIVELY BEFORE STARTING UP THE UNIT. DO NOT THROW IT AWAY. KEEP IT IN YOUR FILES FOR FUTURE REFERENCE.

INTRODUCTION

This operation manual concerns air-cooled condensing units of the Daikin ERAP-MBYNN series. These units are provided for outdoor installation and used for cooling applications.

This manual has been prepared to ensure adequate operation and maintenance of the unit. It will tell you how to use the unit properly and will provide help if problems occur. The unit is equipped with safety devices, but they will not necessarily prevent all problems caused by improper operation or inadequate maintenance.

In case of persisting problems contact your local Daikin Dealer.



Before starting up the unit for the first time, make sure that it has been properly installed. It is therefore necessary to carefully read the installation manual supplied with the unit and the recommendations listed in "Checks before initial start-up" on page 4.

Technical specifications⁽¹⁾

General ERAP		110	150	170
Dimensions HxWxD	(mm)	2160x2340x2238		
Machine weight	(kg)	1326	1440	1516
Connections				
• liquid line	(inch)	7/8" OD		
• suction line	(inch)	2 1/8" OD		
• pressure relief valve outlet	(inch)	FNPT 1"		
Compressor				
Type		semi-hermetic single screw		
Qtyxmodel		1x ZHC3LTGUYE	1x ZHC3WLGUYE	1x ZHC5LMGUYE
Speed	(rpm)	2880		
Oil type		FVC 68D		
Oil charge volume	(l)	5.5	5.5	7.5
Condensor				
Nominal air flow	(m ³ /min)	4x 240	4x 240	4x 240
No. of motorsxoutput	(kW)	4x 0.55	4x 1.02	4x 1.02

Electrical specifications⁽¹⁾

Model ERAP		110	150	170
Power supply				
• Phase			3~	
• Frequency	(Hz)		50	
• Voltage	(V)		400	
• Voltage tolerance	(%)		±10	
Unit				
• Nominal running current	(A)	70	84	104
• Maximum running current	(A)	95	120	135
• Recommended fuses according to IEC 269-2	(A)(gL)	3x 125	3x 160	3x 160
Compressor				
• Phase			3~	
• Frequency	(Hz)		50	
• Voltage	(V)		400	
• Nominal running current	(A)	62	70	90
Control and fan motor				
• Phase			3~	
• Frequency	(Hz)		50	
• Voltage	(V)		400	
• Nominal running current	(A)	7.6	12.4	12.4

Important information regarding the refrigerant used

This product contains fluorinated greenhouse gases covered by the Kyoto Protocol.

Refrigerant type: R407C

GWP⁽¹⁾ value: 1652.5

⁽¹⁾ GWP = global warming potential

Periodical inspections for refrigerant leaks may be required depending on European or local legislation. Please contact your local dealer for more information.

⁽¹⁾ Refer to the engineering data book for the complete list of specifications.

DESCRIPTION

The ERAP air-cooled condensing units are available in 3 standard sizes.

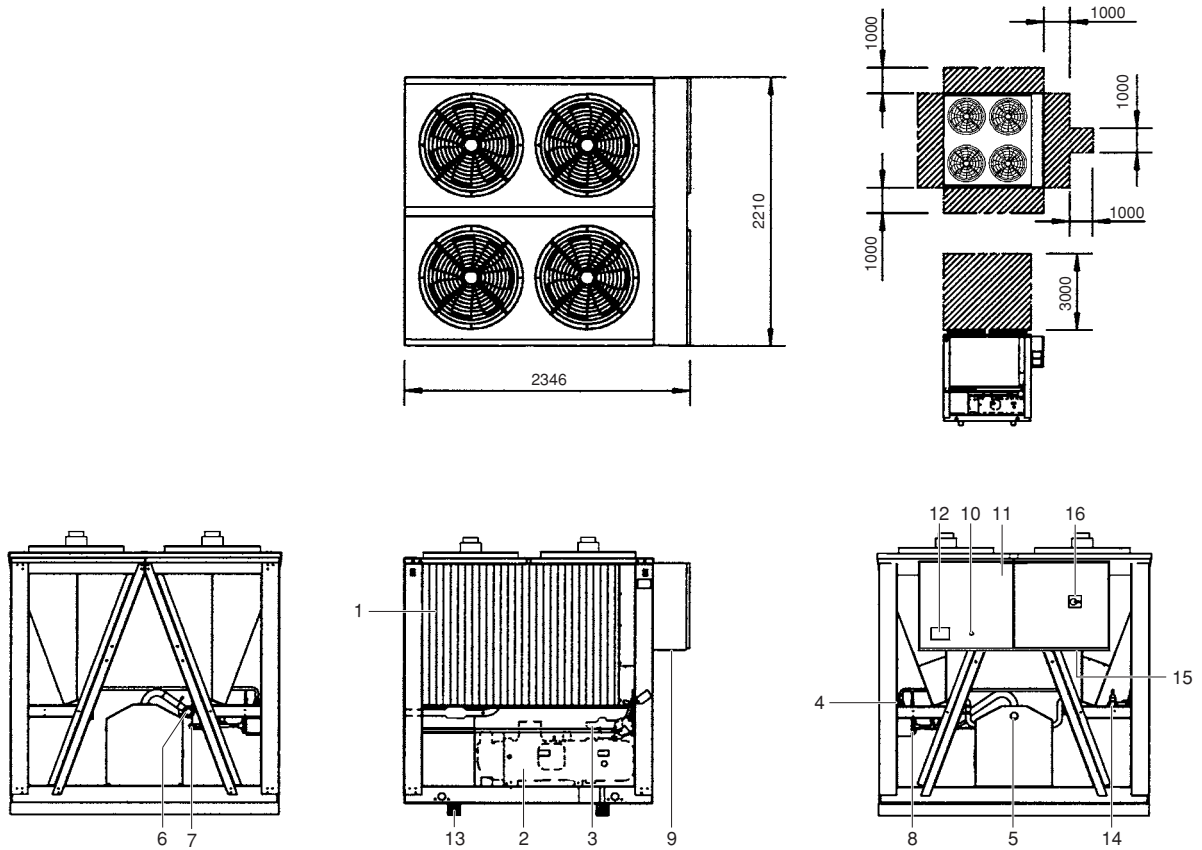



Figure - Main components

- | | | | |
|---|----------------------|----|--|
| 1 | Condenser | 9 | Power supply intake |
| 2 | Compressor (M1C) | 10 | Emergency stop (S5E) |
| 3 | Discharge stop valve | 11 | Switchbox |
| 4 | Liquid stop valve | 12 | Digital display controller |
| 5 | Suction stop valve | 13 | Transportbeam |
| 6 | Suction line | 14 | Ambient temperature sensor (R5T) |
| 7 | Liquid line | 15 | Field wiring intake |
| 8 | Drier + charge valve | 16 | Main isolator switch (optional - S13S) |

 Required space around the unit for service and air intake

Function of the main components

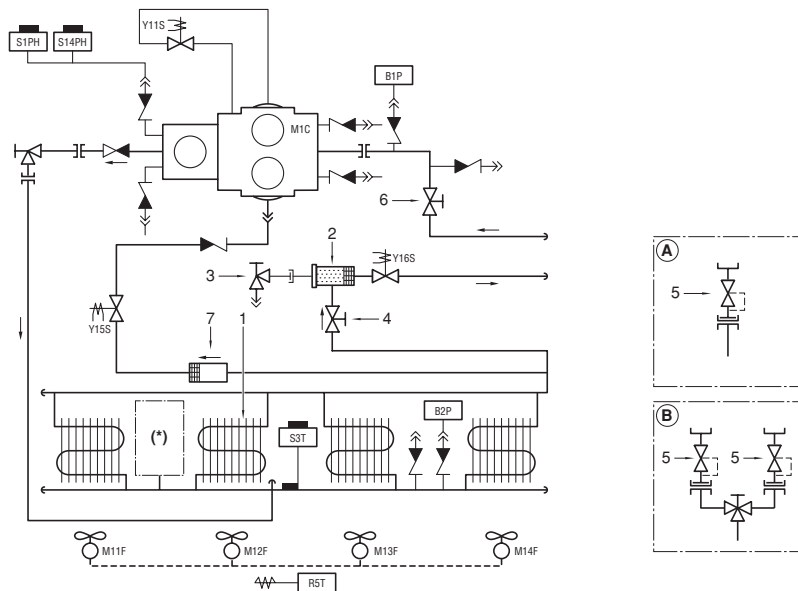

Figure - Functional diagram

- | | | | |
|---|-------------------|-----|--|
| 1 | Condenser | 6 | Suction stop valve |
| 2 | Drier | 7 | Strainer |
| 3 | Charge valve | A | Standard |
| 4 | Liquid stop valve | B | Dual pressure relief valve (OP03) |
| 5 | Safety valve | (*) | Standard (see A) or dual pressure relief valve (see B) |

As the refrigerant circulates through the unit, changes in its state or condition occur. These changes are caused by the following main components:

- **Compressor**
The compressor (M^{*C}) acts as a pump and circulates the refrigerant in the refrigeration circuit. It compresses the refrigerant vapour coming from the evaporator at the pressure at which it can easily be liquefied in the condenser.
- **Condenser**
The function of the condenser is to change the state of the refrigerant from gaseous to liquid. The heat gained by the gas in the evaporator is discharged through the condenser to the ambient air, and the vapour condenses to liquid.
- **Filter/drier**
The filter installed behind the condenser removes small particles from the refrigerant to prevent blockage of the tubes. The drier takes water out of the system.

Safety devices

The unit is equipped with two kinds of safety device:

- 1 **General safety devices**
General safety devices shut down all circuits and stop the whole unit. For this reason the unit has to be manually put on again after a general safety occurred.
- 2 **Part safety devices**
Part safety devices shut down the part they protect.

An overview of all safety devices is given below.

- **Overcurrent relay**
The overcurrent relays (K^{*S}) are located in the switchbox of the unit and protect the compressor motors in case of overload, phase failure or too low voltage. The relays are factory-set and may not be adjusted. When activated, they must be reset manually, followed by a reset of the controller.
- **Compressor thermal protectors**
The compressor motors are equipped with thermal protectors (Q^{*M}). The protectors are activated when the compressor motor temperature becomes too high. When temperature returns to normal, the protectors reset automatically, but the controller needs to be reset manually.
- **Fan motor thermal protector**
The condenser fan motors are equipped with thermal protectors (Q^{*F}). The protectors are activated when the temperature becomes too high. When temperature returns to normal, the protectors reset automatically.
- **Discharge thermal protectors**
The unit is equipped with discharge thermal protectors (S^{*T}). The protectors are activated when the temperature of the refrigerant leaving the compressor becomes too high. When the temperature returns to normal the protector resets automatically and the controller needs to be reset manually.
- **Low pressure safety**
When the suction pressure of a circuit is too low, the circuit controller shuts down the circuit. When the pressure returns to normal, the safety device can be reset on the controller.
- **Pressure relief safety valve**
The safety valve is activated when the pressure in the refrigerant circuit becomes too high. If this occurs, shut down the unit and contact your local dealer.

- High pressure switch
Each circuit is protected by two high pressure switches (S*PH) which measure the condenser pressure (pressure at the outlet of the compressor). They are installed in the compressor housing of the circuit. When the pressure becomes too high, the pressure switches are activated and the circuit stops.
The switches are factory-set and may not be adjusted. When activated, they must be reset by means of a screwdriver. The controller still needs to be reset.
- Reverse phase protector
The reverse phase protectors (R*P) prevent the screw compressors from running in the wrong direction. If the compressors do not start, two phases of the power supply must be inverted.

Internal wiring - Parts table

Refer to the internal wiring diagram supplied with the unit. The abbreviations used are listed below:

A1	**	Current transfo/A-meter
A1P		PCB-controller
B1P		Low pressure transmitter
B2P		High pressure transmitter
C1~C3		Capacitor
E1HC		Crankcase heater compressor
E3H		Evaporator heater
F1U~F3U	#	Main fuses
F4U,F5U	#	Fuses for evaporator heater
F6B		Fuse for primary of TR1
F7B		Fuse for secondary of TR1
F8U		Surge proof fuse for A1P
F9B		Fuse for secondary of TR2
F12B		Fuse for fanmotors
H1P	*	Indication lamp general operation
H2P	*	Indication lamp alarm
H3P	*	Indication lamp operation compressor
H5P	*	Changeable output
J1		Power supply
J11		RS485 connection
J2,J3,J6		Analog input
J5,J7,J8		Digital input
J12~J18		Digital output
K1M		Linecontactor
K2M		Deltacontactor
K3M		Starcontactor
K7F~K9F		Fancontactor
K17S		Overcurrent relay
K1A		Auxiliary relay for safeties
K2A		Auxiliary relay compressor thermal protector
K3A		Auxiliary relay for discharge thermal protector
K7A		Auxiliary relay for safety high pressure
L1,L2,L3		Main supply terminals
M11F-M14F		Fan motors
M1C		Compressor motor
M1S		Stepless capacity control for compressor
PE		Main earth terminal
Q11F~Q14F		Thermal protectors fan motors
Q1M		Thermal protector compressor motor
R1		Auxiliary resistance for feedback

R1F		Feedback resistance
R1P		Reverse phase protector
R4T		Sensor for thermostat
R5T		Sensor for ambient temperature
S1PH		High pressure switch
S3T		Discharge thermal protector
S5E		Emergency stop push button
S6S	*	Changeable switch for remote function (e.g. remote start/stop)
S8L		Flowswitch
S9L	#	Contact that closes if the fan/pump is working
S10S	*	Changeable switch for remote function (e.g. dual setpoint)
S11S	*	Changeable switch for remote function (e.g. enable/disable capacity limitation 1)
S12S	*	Changeable switch for remote function (e.g. enable/disable capacity limitation 2)
S13S	##	Main isolator switch
S14PH		High pressure switch
TC01,TC02		Optocoupler (analog to digital signal)
TR1		Transfo control circuit
TR2		Transfo supply controller + digital inputs
V1		V-meter
Y11S		12% capacity step for compressor
Y15S		Liquid injection valve of the compressor
Y16S		Liquid line solenoid valve

	Not included with standard unit	
	Not possible as option	Possible as option
Obligatory	#	##
Not obligatory	*	**

BEFORE OPERATION

Checks before initial start-up



Make sure that the circuit breaker on the power supply panel of the unit is switched off.

After the installation of the unit, check the following before switching on the circuit breaker:

- 1 Field wiring
Make sure that the field wiring between the local supply panel and the unit has been carried out according to the instructions described in the installation manual, according to the wiring diagrams and according to European and national regulations.
- 2 Additional interlock contact
Additional interlock contacts (S*L) must be provided (e.g. flowswitch, contact of pump motor contactor). Make sure that they have been installed between the appropriate terminals (refer to the wiring diagram supplied with the unit). They must be normal open contacts.
- 3 Fuses or protection devices
Check that the fuses or the locally installed protection devices are of the size and type specified in the installation manual. Make sure that neither a fuse nor a protection device has been bypassed.

4 Earth wiring

Make sure that the earth wires have been connected properly and that the earth terminals are tightened.

5 Internal wiring

Visually check the switch box on loose connections or damaged electrical components.

6 Fixation

Check that the unit is properly fixed, to avoid abnormal noises and vibrations when starting up the unit.

7 Damaged equipment

Check the inside of the unit on damaged components or squeezed pipes.

8 Refrigerant leak

Check the inside of the unit on refrigerant leakage. If there is a refrigerant leak, call your local dealer.

9 Oil leak

Check the compressor on oil leakage. If there is an oil leak, call your local dealer.

10 Stop valves

Open the liquid line, discharge and suction (if provided) stop valves completely.

11 Air inlet/outlet

Check that the air inlet and outlet of the unit is not obstructed by paper sheets, cardboard, or any other material.

12 Power supply voltage

Check the power supply voltage on the local supply panel. The voltage must correspond to the voltage on the identification label of the unit.

Power supply connection and crankcase heating



In order to avoid compressor damage, it is necessary to switch on the crankcase heater for **at least 8 hours** before starting the compressor after a long period of standstill.

To switch on the crankcase heater proceed as follows:

- 1 Switch on the circuit breaker on the local supply panel. Make sure that the unit is "OFF".
- 2 The crankcase heater is switched on automatically.
- 3 Check the supply voltage on the supply terminals L1, L2, L3, by means of a voltmeter. The voltage must correspond to the voltage indicated on the identification label of the unit. If the voltmeter reads values which are not within the ranges specified in the technical data, check the field wiring and replace the supply cables if necessary.
- 4 Check the LED on the reverse phase protectors. If it lights up, the phase order is correct. If not, switch off the circuit breaker and call a licensed electrician to connect the wires of the power supply cable in the correct phase order.
- 5 Check if the crankcase heaters are warming up.

After 8 hours, the unit is ready for operation.

General recommendations

Before switching on the unit, read following recommendations:

- 1 When the complete installation and all necessary settings have been carried out, close all front panels of the unit.
- 2 The service panels of the switch boxes may only be opened by a licensed electrician for maintenance purposes.
- 3 To avoid damage to the LCD display of the digital controller, never switch off the power supply during winter.

OPERATION

The ERAP units are equipped with a digital controller offering a user-friendly way to set up, use and maintain the unit.

This part of the manual has a task-oriented, modular structure. Apart from the first section, which gives a brief description of the controller itself, each section or subsection deals with a specific task you can perform with the unit.

Digital controller

User interface

The digital controller consists of an alphanumeric display, labelled keys which you can press and a number of LEDs.

■ Digital built-in controller

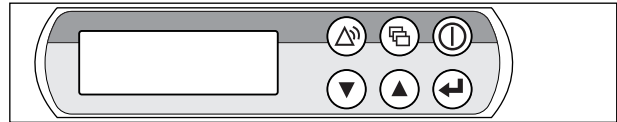

Figure - Digital built-in controller

- key, to enter the main menu
- key, to start up or to shut down the unit.
- key, to enter the safeties menu or to reset an alarm.
- keys, to scroll up or down through the screens of a menu (only in case \triangle , ∇ or \rightarrow appears) or to raise, respectively lower a setting.
- key, to confirm a selection or a setting.

■ Digital remote controller (to be ordered separately)

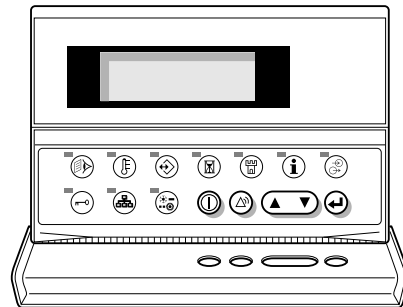

Figure - Digital remote controller

- key, to start up or to shut down the unit.
- key, to enter the safeties menu or to reset an alarm.
- key, to scroll through the screens of a menu (only in case \triangle , ∇ or \rightarrow appears) or to raise, respectively lower a setting.
- key, to confirm a selection or a setting.
- key, to enter the readout menu.
- key, to enter the setpoint menu.
- key, to enter the user settings menu.
- key, to enter the timers menu.
- key, to enter the history menu.
- key, to enter the info menu.
- key, to enter the input/output status menu.
- key, to enter the user password menu.
- key, has no effect on ERAP units.
- key, has no effect on ERAP units.

NOTE Temperature readout tolerance: $\pm 1^{\circ}\text{C}$.



Legibility of the alphanumeric display may decrease in direct sunlight.

How to enter a menu

- Digital built-in controller (main menu)
Scroll through the main menu using the \blacktriangle and \blacktriangledown keys to move the \blacktriangleright mark in front of the menu of your choice. Push the \ominus key to enter the selected menu.

```
>READOUT MENU
SETPOINTS MENU
USERSETTINGS MENU
TIMERS MENU
HISTORY MENU
INFO MENU
I/O STATUS MENU
USERPASSWORD MENU
```

- Digital remote controller
Press the corresponding menu key indicated in "User interface", paragraph "Digital remote controller" on page 5

Connection of a remote digital controller to the unit

For a remote digital controller a cable length of up to 600 metres between the remote digital controller and the unit is allowed. This gives the opportunity to control the unit from a considerable distance. Refer to "Cable for remote digital controller" in the installation manual for cable specifications.

NOTE When a remote digital controller is connected to a stand-alone unit, the address of the remote digital controller has to be set to 2 by means of the DIP-switches on the back of the remote digital controller. Refer to the installation manual "Setting the addresses on the remote digital controller" for setting the address.

Working with the unit

This chapter deals with the everyday usage of the unit. Here, you will find how to perform routine tasks, such as:

- "Setting the language" on page 6
- "Switching the unit on" on page 6
- "Consulting actual operational information" on page 6
- "Resetting the unit" on page 7

Setting the language

If wanted, the operating language can be changed to any of the following languages: English, German, French, Spanish or Italian.

- 1 Enter the user settings menu. Refer to chapter "How to enter a menu" on page 6
- 2 Select the appropriate field using the \ominus key.
- 3 Press \ominus to change the operating language until the desired language is active.

Switching the unit on

- 1 Press the $\text{\textcircled{O}}$ key on the controller.
Depending on whether or not a remote ON/OFF switch has been configured (refer to the installation manual), the following conditions may occur.
When no remote ON/OFF switch is configured, the LED inside the $\text{\textcircled{O}}$ key lights up and an initialization cycle is started. Once all the timers have reached zero, the unit starts up.
When a remote ON/OFF switch is configured, the following table applies:

Local key	Remote switch	Unit	$\text{\textcircled{O}}$ LED
ON	ON	ON	ON
ON	OFF	OFF	Flashing
OFF	ON	OFF	OFF
OFF	OFF	OFF	OFF

- 2 If the condensing unit does not start after a few minutes, refer to "Troubleshooting" on page 13.

Switching the unit off

If no remote on/off switch is configured:

Press the $\text{\textcircled{O}}$ key on the controller.
The LED inside the $\text{\textcircled{O}}$ key goes out.

If a remote on/off switch is configured:

Press the $\text{\textcircled{O}}$ key on the controller or switch the unit off using the remote on/off switch.
The LED inside the $\text{\textcircled{O}}$ key goes out in the first case and starts blinking in the second case.



In case of emergency, switch off the unit by pushing the emergency stop button.

NOTE Also consult "Defining the capacity limitation settings" on page 10 and "Customization in the service menu" chapter "Setting of the changeable inputs and outputs" in the installation manual.

Consulting actual operational information

- 1 Enter the readout menu. Refer to the chapter "How to enter a menu" on page 6.
The controller automatically shows the first screen of the readout menu which provides the following information:
 - MANUAL MODE or SETPOINT 1/2: manual/automatic control mode operation. If the automatic control mode is selected, the controller will indicate the active temperature setpoint. Depending on the status of the remote contact, setpoint one or setpoint two is active.
 - TEMP SENSOR: actual temperature of sensor thermostat R4T.
- 2 Press the \blacktriangledown key to enter the next screen of the readout menu.
The UNIT STATUS screen of the readout menu provides information concerning the status of the different circuits.
 - C1: actual status of circuit.
When the circuit is ON, the following status information may appear.
 - C1: 40% - this percentage refers to the activated capacity valve of that specific circuit.



NOTE When a circuit is in a high pressure setback, the indication of capacity will be flashing. A high pressure setback is a prevention of load-up or a forced load-down caused by a too high pressure.

When a circuit is OFF, the following status information may appear.

- **SAFETY ACTIVE:** one of the circuit safety devices is activated (refer to "Troubleshooting" on page 13).
- **⟨LIMIT⟩:** the circuit is limited by a remote contact.
- **TIMERS BUSY:** the actual value of one of the software timers is not zero (refer to "Timers menu" on page 8).
- **CAN STARTUP:** the circuit is ready to start up when extra cooling load is needed.

The preceding OFF messages are written down in order of priority. If one of the timers is busy and one of the safeties is active, the status information says SAFETY ACTIVE.

The UNIT CAPACITY is written down on the bottom of the screen. The percentage is the actual cooling capacity of the unit.

- 3 Press the key to enter the next screen of the readout menu. The ACTUAL PRESSURES screen of the readout menu provides information concerning the pressures of circuit.
 - **HP1:** high pressure of the refrigerant in circuit. The first number stands for the pressure in bar, the second number stands for the bubble point saturation temperature in degrees Celsius.
 - **LP1:** low pressure of the refrigerant in circuit. The first number stands for the pressure in bar, the second number stands for the dew point saturation temperature in degrees Celsius.
- 4 Press the key to enter the next screen of the readout menu. This menu is available if voltage and current transmitters are installed. This readout menu provides information concerning the voltage and the compressor current.
- 5 Press the key to enter the next screen of the readout menu. To consult actual operational information about the ambient temperature and the total running hours of the compressor.
- 6 Press the key to return to the other readout menus.

Adjusting the temperature setpoint

The unit provides definition and selection of two independent temperature setpoints.

- **SETPOINT 1:** setpoint 1,
- **SETPOINT 2:** setpoint 2.

The selection between setpoint 1 and 2 is done by a remote dual setpoint switch (to be installed by the customer). The actual active setpoint can be consulted in the readout menu.

NOTE The customer is also allowed to define a setpoint in function of an analog input.

NOTE Refer to "Customization in the service menu" chapter "Setting of the changeable inputs and outputs" in the installation manual

If the manual control mode is selected (refer to "User settings menu" on page 8), none of the above-mentioned setpoints will be active.

To adjust a setpoint, proceed as follows:

- 1 Enter the setpoints menu. Refer to the chapter "How to enter a menu" on page 6. If the user password is disabled for setpoint modifications (refer to "User settings menu" on page 8), the controller will immediately enter the setpoints menu. If the user password is enabled for setpoint modifications, enter the correct code using the and keys (refer to "User password menu" on page 9). Press to confirm the password and to enter the setpoints menu.

- 2 Select the setpoint to be adjusted using the key. A setpoint is selected when the cursor is blinking behind the setpoint's name. The ">" sign indicates the actual active temperature setpoint.
- 3 Press the and keys to adjust the temperature setting. The default, limit and step values for the cooling temperature setpoints are:

SETPOINT	
default value	7°C
limit values ^(a)	4 --> 16°C
step value	0.1 °C

(a) The lower limit of the cooling temperature setpoint can be adapted by changing the minimum operating temperature in the service menu (refer to the installation manual). The following values apply:
SETPOINT: 2°C, 0°C, -5°C, -10°C

- 4 Press to save the adjusted temperature setpoint. When the setting has been confirmed, the cursor switches to the next setpoint.
- 5 To adjust other setpoints, repeat from step 2.

NOTE Also consult "Defining the floating setpoint settings" on page 10.

Resetting the unit

When a unit safety occurs, one compressor is shut down. The safeties menu will indicate which safety is activated. The UNIT STATUS screen of the readout menu will indicate OFF - SAFETY ACTIVE. The red LED inside the key lights up and the buzzer inside the controller is activated.

If the unit has been shut down due to a power failure, it will carry out an autoreset and restart automatically when the electrical power is restored.

To reset the unit, proceed as follows:

- 1 Press the key to acknowledge the alarm. The buzzer is de-activated. The controller automatically switches to the corresponding screen of the safeties menu: unit safety or circuit safety or network safety.
- 2 Find the cause of shutdown and correct. Refer to "Listing activated safeties and checking the unit status" on page 11 and "Troubleshooting" on page 13. When a safety can be reset, the LED under the key starts blinking.
- 3 Press the key to reset the safeties that are no longer active. If required, enter the USER PASSWORD or the SERVICE PASSWORD. (Refer to the installation manual "Setting the password for safety reset".) Once all safety devices are de-activated and reset, the LED under the key goes out. If one of the safeties is still active, the LED under the key goes on again. In this case, return to step 2.

If the user shuts down the power supply in order to repair a safety, the safety will automatically be reset after power-up.

NOTE The history information, i.e. the number of times a unit safety or a circuit safety occurred and the unit status at the moment of shutdown, can be checked by means of the history menu.

Advanced features of the digital controller

This chapter gives an overview and a brief functional description of the screens provided by the different menus. In the following chapter, you will find how you can set up and configure the unit using the various menu functions.

All menus are directly accessible using the corresponding key on the digital controller or through the main menu (refer to "How to enter a menu" on page 6). The down arrow \downarrow on the display indicates that you can go to the next screen of the current menu using the \odot key. The up arrow \uparrow on the display indicates that you can go to the previous screen of the current menu using the \blacktriangle key. If \div is displayed, this indicates that you can either return to the previous screen or can go to the next screen.

Readout menu

\downarrow SETPOINT1: 07.0°C TEMP.SENSOR : 08.0°C	To consult actual operational information about the control mode.
\div UNIT STATUS C1:OFF-CAN STARTUP UNITCAPACITY:000%	To consult information about the unit status.
\div ACT. PRESSURES C1 HP1: 19.0b = 50.8°C LP1: 4.4b = 5.2°C	To consult information about the pressures.
\downarrow EXTRA READOUT RH1:00000h CS1:00000 AMBIENT: 20.0°C	To consult actual operational information about the ambient temperature, the total running hours of the compressor and the number of compressor starts.

Setpoints menu

Depending upon the settings in the user settings menu, the "setpoints" menu can either be entered directly or by means of the user password.

>SETPOINT1: 07.0°C SETPOINT2: 07.0°C	To define the temperature setpoints.
---	--------------------------------------

User settings menu

The "usersettings" menu, protected by the user password, allows a full customization of the units.

\downarrow CONTROL SETTINGS MODE:THERMOSTAT CIR1: 70% F1* :MED	To define the manual settings and to activate or de-activate manual control mode or thermostat mode.
\div THERMOST.SETTINGS LOADUP:012s-DWN:012s	To define the thermostat settings.
\div CAP. LIM. SETTINGS MODE:REMOTE DIG INP. L1CIR1:100% L2CIR1:100%	To define the capacity limitations (first screen).
\div CAP. LIM. SETTINGS L3CIR1:100% L4CIR1:100%	To define the capacity limitations (second screen).
\div PUMPCONTROL PUMPLEADTIME: 000s PUMPLAGTIME : 000s DAILY ON:N AT:12h00	To define the fan or pump settings.

\div SCHEDULE TIMER
ENABLE TIMER:Y
ENABLE HOLIDAY PER:Y

To define the schedule timer. According to the settings of ENABLE TIMER and ENABLE HOLIDAY PER following screens will be available or not.

\div HD PERIOD:01 TO 03
01:00/00 TO 00/00
02:00/00 TO 00/00
01:00/00 TO 00/00

\div DUAL EVAP. PUMP
MODE:AUTOM. ROTATION
OFFSET ON RH: 048h

To define the dual evaporator pump.

\div DISPLAY SETTINGS
PRESS ENTER TO
CHANGE LANGUAGE:
ENGLISH

To define the display settings (first screen).

\div DISPLAY SETTINGS
TIME: 00h00
DATE: MON 01/01/01

To define the display settings (second screen).

\div SETPOINT PASSWORD
PASSWORD NEEDED TO
CHANGE SETPOINTS: Y

To define whether or not a password is needed to enter the setpoints menu.

\div ENTER SERVICE
PASSWORD: 0000

To the service menu (only a qualified installer is allowed to access this menu).

Timers menu

\downarrow GENERAL TIMERS
LOADUP:000s DWN:000s
PUMPLEAD : 000s
FLOWSTOP : 00s

To check the actual value of the general software timer.

\div COMPRESSOR TIMERS
COMPR. STARTED :00s

To check the actual value of the compressor timer. (first screen)

\div COMPRESSOR TIMERS
GRD1:000s AREC1:000s

To check the actual value of the compressor timer. (second screen)

\wedge COMPRESSOR TIMERS
START1:000s STOP:00s

To check the actual value of the compressor startup timer and the stop timer.

Safeties menu

The "safeties" menu provides useful information for trouble shooting purposes. The following screens contain basic information.

\downarrow UNIT SAFETY
0HC:INL C SENSOR ERR

To consult information about the unit safety which caused the shutdown.

\downarrow CIRCUIT1 SAFETY
IUI1:REV PHASE PROT

To consult information about the circuit safety which caused the shutdown.

\downarrow NETWORK SAFETY
0U4:PCB COMM.PROBLEM

To consult information about the network safety which caused the shutdown.

\downarrow UNIT WARNING
0AE:FLOW HAS STOPPED

To consult information about the dual pump which caused the shutdown.

Along with the basic information, more detailed information screens can be consulted while the safety menu is active. Press the \odot key. Screens similar to the following will appear.

```

└─V UNIT HISTORY:002
0HC:INL C SENSOR ERR
00h00 - 01/01/01
MANUAL MODE

```

To check the time and control mode at the moment of the unit shutdown.

```

└─ UNIT HISTORY:002
0HC:INL C SENSOR ERR
TEMP.SENSOR: 08.0°C

```

To check which was the sensor temperature.

```

└─ UNIT HISTORY:002
0HC:INL C SENSOR ERR
C1:OFF-CAN STARTUP

```

To check which was the status of the compressors at the moment of shutdown.

```

└─ UNIT HISTORY:002
0HC:INL C SENSOR ERR
HP1: 19.0b = 50.8°C
LP1: 4.4b = 5.2°C

```

To check which were the pressures of the circuit at the moment of shutdown.

```

└─ UNIT HISTORY:002
0HC:INL C SENSOR ERR
RH 1:00000h AMB.T:
20.0°C

```

To check which were the total amount of running hours of the compressor and the ambient temperature at the moment of shutdown.

```

└─CHANG. DIG. INPUTS
DI1 NONE
DI2 NONE
DI3 NONE

```

To check the status of the changeable digital inputs.

```

└─ RELAY OUTPUTS
CIRCUIT 1 ON :NO
CIRCUIT 1 STAR :NO
CIRCUIT 1 DELTA:NO

```

To check the status of the power relays.

```

└─ RELAY OUTPUTS
C1(12%):N
C1CAPUP:N DOWN:N
C1FEEDBACK: 030.0n

```

To check the capacity mode.

```

└─ RELAY OUTPUTS
C1 FANSTEP 1:CLOSED
C1 FANSTEP 2:CLOSED
C1 FANSTEP 3:CLOSED

```

To check the status of the fanspeed relays.

```

└─ RELAY OUTPUTS
GEN. ALARM:CLOSED
PUMP/GEN OPER:CLOSED
AI1:NONE

```

To check the status of the air- or waterflow contact and the alarm contact.

```

└─CHANG. INP/OUTPUTS
DI4 NONE
DO1 EVAP.HEATERT. :C
DO2 2ND EVAP PUMP :0

```

To check the status of the changeable relay output.

History menu

The "history" menu contains all the information concerning the latest shutdowns. The structure of those menus is identical to the structure of the safeties menu. Whenever a failure is solved and the operator performs a reset, the concerning data from the safeties menu is copied into the history menu.

Additionally the number of safeties that already occurred, can be consulted on the first line of the history screens.

Info menu

```

└─V TIME INFORMATION
TIME: 00h00
DATE: MON 01/01/01

```

To consult time and date information.

```

└─ UNIT INFORMATION
UNIT:AW-CO-170 C:STL
CIR:1 EVAP:1 FAN:3ST
REFRIGERANT :R407C

```

To consult additional information about the unit such as the unit type and the refrigerant used.

```

└─ UNIT INFORMATION
SW:4.0M6 -01/03/05
SW CODE: FLDKNMCHLA

```

To consult information about the controller's software version.

```

└─ PCB INFORMATION
BOOT:U3.01-15/07/02
BIOS:U3.61-05/11/04
PLAN ADDRESS: 01

```

To consult information about the PCB.

Input/output menu

The "input/output" menu gives the status of all the digital inputs and the relay outputs of the unit.

```

└─V DIGITAL INPUTS
EMERGENCY STOP :OK
FLOWSWITCH:FLOW OK

```

To check whether or not the emergency stop device is active and if the air- or waterflow is right.

```

└─ DIGITAL INPUTS
C1 HIGH PR.SW. :OK
C1 REV.PH.PROT.:OK
C1 OVERCURRENT :OK

```

To check the status of the high pressure switch and of the reverse phase protector.

```

└─ DIGITAL INPUTS
C1 DISCH.TH.PR.:OK
C1 COMPR.TH.PR.:OK

```

To check the status of the discharge thermal protector and the compressor thermal protector.

User password menu

```

└ CHANGE PASSWORD
NEW PASSWORD: 0000
CONFIRM: 0000

```

To change the user password.

Tasks of the user settings menu

Entering the user settings menu

The user settings menu is protected by the user password, a 4-digit number between 0000 and 9999.

1 Enter the USERSETTINGS MENU. (Refer to the chapter "How to enter a menu" on page 6).

The controller will request the password.

2 Enter the correct password using the \blacktriangle and \blacktriangledown keys.

3 Press \odot to confirm the password and to enter the user settings menu.

The controller automatically enters the first screen of the user settings menu.

To define settings of a custom function;

1 Go to the appropriate screen of the usersettings menu using the \blacktriangle and \blacktriangledown keys.

2 Position the cursor behind the parameter to be modified using the \odot key.

3 Select the appropriate setting using the \blacktriangle and \blacktriangledown keys.

4 Press \odot to confirm the selection.

When the selection has been confirmed, the cursor switches to the next parameter which can now be modified.

5 Repeat from instruction 2 onwards to modify the other parameters.

Defining and activating the control mode

The unit is equipped with a thermostat which controls the capacity of the unit.

Two different control modes exist:

- Manual control mode: the operator controls the capacity himself - **MANUAL CONTROL**
 - F1* (air flow in manual mode): off, low, medium or high.
 - CIR1 (capacity step in manual mode): 0%, 30%~100%.
- Thermostat mode: uses the thermostat control to control the capacity of the unit - **THERMOSTAT**

 **NOTE** To activate manual control mode, select **MANUAL** as present mode. To deactivate the manual control mode, select **THERMOSTAT** as present mode.

Defining the thermostat settings

When automatic control mode is selected, the unit uses a thermostat function to control the cooling capacity. However, the thermostat parameters are not fixed and can be modified via the **THERMOST. SETTINGS** screen of the user settings menu.

The default, limit and step values for the thermostat parameters are shown in "[Annex I](#)" on page 15.

 **NOTE**

- If changed on one of the units in a DICN configuration, this setting is transferred to all other units in the network.
- A functional diagram showing the thermostat parameters can be found in "[Annex I](#)" on page 15.

Defining the capacity limitation settings

A capacity limitation can be activated:

- **MODE:**
 - **SCHEDULE TIMER:** see "[Defining the schedule timer](#)" on page 10.
 - **REMOTE DIG INP:** when a changeable input is configured as capacity limitation.

 **NOTE** Refer to "Customization in the service menu", chapter "Setting of the changeable digital inputs and outputs" in the installation manual

- **LIM1:** to activate capacity limitation 1.
 - **NOT ACTIVE:** the capacity limitation is not active.
 - **L1/L2/L3/L4 CIR 1:** capacity limitation value of circuit 1 in case of capacity limitation 1/2/3/4.
-

Defining the flow control settings

The **FLOWCONTROL** screen of the user settings menu allows the user to define the pump-leadtime and pump-lagtime.

- **FLOWLEADTIME:** used to define the time that the fan or pump-motor must run before the unit starts.
 - **FLOWLAGTIME:** used to define the time that the fan or pumpmotor keeps running after the unit is stopped.
-

Defining the schedule timer

To activate the screens of the schedule timer or holiday period, these first need to be enabled by changing their setting to **Y** in the appropriate screen. To de-activate the schedule timer or holiday period, their setting needs to be reset to **N**. (See "[User settings menu](#)" on page 8.)

The **SCHEDULE TIMER** screen of the user settings menu allows the user to define the schedule timer settings.

Each day of the week can be appointed to a group. The actions defined in a group will be executed in each day belonging to that group.

- **MON, TUE, WED, THU, FRI, SAT and SUN:** used to define to which group each day of the week belongs (-/G1/G2/G3/G4).
 - For each of the four groups up to nine actions can be set, each with their respective timing. Actions include: putting the unit on/off and setting capacity limitation.
 - Beside these four groups there is also a holiday period group which is set the same way as the other groups. Up to 12 holiday periods can be entered in the **HOLIDAY PERIOD** screen. During these periods the schedule timer will follow the settings of the holiday period group.
-

 **NOTE** A functional diagram showing the schedule timer working can be found in "[Annex I](#)" on page 15.

 **NOTE** The unit always works with "last command". This means that the last command given, whether manually by the user or by the schedule timer, is always executed.
Examples of command that can be given are switching the unit on/off or changing a setpoint.

Defining dual evaporator fan/pump control

The **DUAL EVAP. PUMP** screen of the user settings menu allows the user to define the steering of 2 evaporator fans/pumps (for this to be possible a changeable digital output has to be configured for a second evaporator fan/pump in the service menu). Refer to the installation manual.

- **MODE:** used to define which kind of control will be used for the two evaporator pumps. When automatic rotation is chosen the offset on running hours also has to be entered.
 - **AUTO:** pump 1 and pump 2 will alternate to the offset on RH.
 - **PUMP 1>PUMP 2:** pump 1 will always start up first.
 - **PUMP 2>PUMP 1:** pump 2 will always start up first.
 - **OFFSET ON RH:** used to define the offset in running hours between the two pumps. Used to switch over between pumps when they work in automatic rotation mode.
-

Defining the floating setpoint settings

The **FLOATING SETPOINT** screen of the user settings menu allows the active setpoint to be modified in function of the ambient. The source and settings of the floating setpoint can be configured by the user.

- **SOURCE:** used to define the mode of the floating setpoint.
 - **NOT PRESENT:** floating setpoint is not activated.
 - **AMBIENT:** floating setpoint is altered based on the ambient temperature.
 - **MAX. VALUE:** used to define maximum value that can be added to the active setpoint.
 - **D1:** used to define the ambient (source) at which the floating setpoint value is equal to zero.
 - **D2:** used to define the rise in floating setpoint value for 10°C drop in ambient.
-

 **NOTE** A functional diagram showing the floating setpoint working can be found in "[Annex III](#)" on page 15.

Defining the display settings

The **DISPLAY SETTINGS** screens of the usersettings menu allows the user to define the choice of language, time and date.

- **LANGUAGE:** used to define the language of the displayed information of the controller (on the first screen). (Push the  button repeatedly to change the operating language).
 - **TIME:** used to define the present time (on the second screen).
 - **DATE:** used to define the present date (on the second screen).
-

Defining BMS control

BMS allows the user to control the unit from a supervisory system.

The BMS SETTINGS screen and BMSBOARD SETTINGS screen of the service menu have to be used to set BMS parameters. Refer to "Customization in the service menu" chapter "Defining the BMS settings" in the installation manual.

Tasks of the timers menu

Checking the actual value of the software timers

As a protective measure and to ensure correct operation, the controller's software features several countdown timers:

- **LOADUP (LOADUP** – refer to the thermostat parameters): starts counting when a thermostat step change has occurred. During the countdown, the unit is not able to enter a higher thermostat step.
- **LOADDOWN (DOWN** – refer to the thermostat parameters): starts counting when a thermostat step change has occurred. During the countdown, the unit will not be able to go to a lower thermostat step.
- **FLOWSTART (FLOWSTART** – 15 sec): counts down when the airflow/waterflow interlock contact is closed. During the countdown, the unit cannot start up.
- **FLOWLEAD (FLOWLEAD** – refer to the flow control settings): starts counting whenever the unit is switched on. During the countdown, the unit cannot start up.
- **FLOWLAG (FLOWLAG** – refer to the flow control settings): starts counting whenever the unit is switched off. During the countdown, the fan motor or pump motor keeps running.
- **STARTTIMER (COMPRESSOR STARTED** – 10 sec): starts counting whenever a compressor starts up. During the countdown, no other compressor can start up.
- **GUARDTIMER (GRD1** – 60 sec): starts counting when the compressor has been shut down. During the countdown, the compressor cannot be restarted.
- **ANTIRECYCLING (AREC1** – 600 sec): starts counting when the compressor has started. During the countdown, the compressor cannot be restarted.
- **STARTUPTIMER (STARTUPTIME1** – 180 sec): starts counting when the compressor has started. During the countdown, the compressor is limited to a maximum capacitystep of 30%.

To check the actual value of the software timers, proceed as follows:

- 1 Enter the **TIMERS MENU**. (Refer to the chapter "How to enter a menu" on page 6.)
The controller displays the actual value of the **GENERAL TIMERS**: the loadup timer, the loaddown timer, the flowstart timer, the flow-stop timer (when the unit is on and the flowstart timer has reached zero), the pumplead timer and the pumplag timer.
- 2 Press the **▼** key to check the compressor timers.
The controller shows the actual value of the **COMPRESSOR TIMERS**: the guard timers (one per circuit) and the antirecycling timers (one per circuit).
- 3 Press the **▼** key to check the remaining timers.
The controller shows the actual value of the **STARTUP TIMERS**.

Tasks of the safeties menu

Listing activated safeties and checking the unit status

If the alarm buzzer is activated and the user presses the **Ⓜ** key, the controller automatically enters the safeties menu.

- The controller will enter the **UNIT SAFETY** screen of the safeties menu when a unit safety was the cause of shutdown.
 - The controller will enter the **CIRCUIT 1 SAFETY** screen of the safeties menu when a safety of the circuit was activated.
- 1 Press the **Ⓜ** key when the alarm buzzer is activated.
The appropriate safety screen with the basic information appears. Press the **Ⓜ** key to see the detailed information.
 - 2 If more than one kind of safety is active (indicated by means of **△, ▽** or **⊕**), use the **▲** and **▼** keys to consult them.

Tasks of the history menu

Checking the safety info and the unit status after a reset

The information available in the safeties menu is also stored in the history menu, where it is stored after resetting the unit or the circuit. In this way, the history menu provides a means of checking the unit status at the moment of the latest shutdown.

To check the safety info and the unit status, proceed as follows:

- 1 Enter the **HISTORY MENU**. (Refer to the chapter "How to enter a menu" on page 6.)
The controller enters the **UNIT HISTORY** screen which contains the following information: the number of shutdowns, the unit safety which caused the most recent shutdown and the basic information at the moment of this shutdown.
- 2 Press the **▲** and **▼** keys to consult the **M1, M2** or **M3 HISTORY** screens.
- 3 Press the **Ⓜ** key to see the detailed information.

Tasks of the info menu

Consulting additional unit information

- 1 Enter the **INFO MENU** through the main menu. (Refer to the chapter "How to enter a menu" on page 6.)
The controller enters the **TIME INFORMATION** screen which contains the following information: the time and date.
- 2 Press **▼** to consult the first **UNIT INFORMATION** screen.
This screen contains information about the unit name and the refrigerant used.
- 3 Press **▼** to consult the next **UNIT INFORMATION** screen.
This screen contains information about the controller's software version.
- 4 Press **▼** to consult the **PCB INFORMATION** screen.
This screen contains information about the PCB.

Tasks of the input/output menu

Checking the status of the inputs and outputs

The input/output menu provides a means of checking the status of the digital inputs and the status of the relay outputs.

The locked digital inputs are:

- EMERGENCY STOP: whether the emergency button has been pressed.
- FLOW: indicates the status of the air- or waterflow contact: activated or de-activated.
- HIGH PRESSURE SWITCH 1: indicates the actual status of this safety.
- REVERSE PHASE PROTECTOR 1: indicates the actual status of this safety.
- OVERCURRENT 1: indicates the actual status of this safety.
- DISCHARGE THERMAL PROTECTOR 1: indicates the actual status of this safety.
- COMPRESSOR THERMAL PROTECTOR 1: indicates the actual status of this safety.

The changeable digital inputs are:

- CAP LIM 1/2/3/4: indicates the position of the "enable/disable capacity limitation" switches.
- REM. ON/OFF: indicates the position of the remote on/off switch.
- STATUS: indicates the position of the connected switch.

The locked relay outputs are:

- CIRCUIT 1 ON: indicates whether the circuit is on or off.
- CIRCUIT 1 STAR: indicates whether the circuit is in starmode or not.
- CIRCUIT 1 DELTA: indicates whether the circuit is in deltamode or not.
- C 1 <12%>: indicates if the 12% capacity valve of the circuit is activated.
- C1 CAPUP: indicates if the UP of the capacity control motor of the circuit is activated.
- C1 CAPDWN: indicates if the DWN of the capacity control motor of the circuit is activated.
- C1 FEEDBACK: indicates the FEEDBACK of the potentiometer of the circuit (Ω).
- C 1 FANSTEP 1: indicates if the fans of fanstep 1 for the circuit are on or not.
- C 1 FANSTEP 2: indicates if the fans of fanstep 2 for the circuit are on or not.
- C 1 FANSTEP 3: indicates if the fans of fanstep 3 for the circuit are on or not.
- FLOWCONTACT: indicates the status of this voltage free contact. It is activated if the fan motor or the pump motor should be ON.
- GEN. ALARM: indicates the status of this voltage free contact. It is activated if there is any alarm on the unit.

The changeable relay outputs are:

- 2ND EVAP PUMP: indicates the status of the second evaporator pump.
- 100% CAPACITY: indicates when the unit is working at 100%.
- 1 <CLOSED>: indicates the closed status of the changeable digital output.

The changeable analog inputs are:

- SETP.SIGN. 0mV: indicates the status of the analog input
- SETP.SIGN. 0.0V: indicates the status of the analog input
- SETP.SIGN. 0mA: indicates the status of the analog input

To check the inputs and outputs, proceed as follows:

- 1 Enter the I/O STATUS MENU. (Refer to the chapter "How to enter a menu" on page 6.)
The controller enters the first DIGITAL INPUTS screen.
- 2 Consult the other screens of the input/output menu using the \blacktriangle and \blacktriangledown keys.

Tasks of the user password menu

Changing the user password

Access to the user settings menu and the setpoints menu is protected by the user password (a 4-digit number between 0000 and 9999).

NOTE The default user password is 1234.



To change the user password, proceed as follows:

- 1 Enter the USERPASSWORD MENU. (Refer to the chapter "How to enter a menu" on page 6).
The controller will request the password.
- 2 Enter the correct password using the \blacktriangle and \blacktriangledown keys.
- 3 Press \odot to confirm the password and to enter the password menu.
The controller requests the new password.
- 4 Press \odot to start the modification.
The cursor is positioned behind NEW PASSWORD.
- 5 Enter the new password using the \blacktriangle and \blacktriangledown keys.
- 6 Press \odot to confirm the new password.
When the new password has been confirmed, the controller will ask to enter the new password a second time (for safety reasons). The cursor is positioned behind CONFIRM.
- 7 Enter the new password again using the \blacktriangle and \blacktriangledown keys.
- 8 Press \odot to confirm the new password.

NOTE The actual password will only be changed when the new password and the confirmed password have the same value.



TROUBLESHOOTING

This section provides useful information for diagnosing and correcting certain troubles which may occur in the unit.

Before starting the troubleshooting procedure, carry out a thorough visual inspection of the unit and look for obvious defects such as loose connections or defective wiring.

Before contacting your local dealer, read this chapter carefully, it will save you time and money.



When carrying out an inspection on the supply panel or on the switch box of the unit, always make sure that the circuit breaker of the unit is switched off.

Overview of safety messages

Message safety menu		Symptom
UNIT SAFETY	ØFØ:EMERGENCY STOP	3
	ØAE:FLOW HAS STOPPED	5.7
	ØH9:AMB T SENSOR ERR	10
	ØCJ:THERM SENSOR ERR	10
CIRCUIT 1 SAFETY	1U1:REV PHASE PROT	5.5
	1E3:HIGH PRESSURE SW	5.3
	1E5:COMPR THERM PROT	5.8
	1E6:OVERCURRENT	5.1
	1F3:DISCH THERM PROT	5.6
	1E4:LOW PRESSURE	5.2
	1JA:HP TRANSN ERR	10
	1JC:LP TRANSN ERR	10
	193:CONTR.MOTOR ERR	8
	194:CONTR.MOTOR REV	9
UNIT WARNING	ØAE:FLOW HAS STOPPED	5.7

When a safety device was activated, stop the unit and find out why the safety device was activated before resetting it. Under no circumstances safety devices may be bridged or changed to a value other than the factory setting. If the cause of the problem cannot be found, call your local dealer.

Symptom 1: The unit does not start, but the ON LED lights up

POSSIBLE CAUSES	CORRECTIVE ACTION
All thermostat contacts are open.	Check the thermostat contacts.
The flowstart timer is still running.	The unit will start after approx. 15 seconds. Make sure that the cooling source is flowing over/through the evaporator.
The circuit can not start up.	Refer to Symptom 4: The circuit does not start up.
Unit is in manual mode (all compressors at 0%).	Check on the controller.
Power supply failure.	Check the voltage on the supply panel.
Blown fuse or interrupted protection device.	Inspect fuses and protection devices. Replace by fuses of the same size and type (refer to "Electrical specifications" on page 1).
Loose connections.	Inspect connections of the field wiring and the internal wiring of the unit. Tighten all loose connections.
Shorted or broken wires.	Test circuits using a tester and repair if necessary.

Symptom 2: The unit does not start, but the ON LED is flashing

POSSIBLE CAUSES	CORRECTIVE ACTION
The remote ON/OFF input is enabled and the remote switch is off.	Put the remote switch on or disable the remote ON/OFF input.

Symptom 3: The unit does not start and the ON LED does not light up

POSSIBLE CAUSES	CORRECTIVE ACTION
The unit is in failure mode.	Refer to Symptom 5: One of the following safety devices is activated.
One of the following safety devices is activated: <ul style="list-style-type: none"> Air- or waterflow contact (S9L) Emergency stop 	Refer to Symptom 5: One of the following safety devices is activated.
The ON LED is broken.	Contact your local dealer.

Symptom 4: The circuit does not start up

POSSIBLE CAUSES	CORRECTIVE ACTION
One of the following safety devices is activated: <ul style="list-style-type: none"> Compressor thermal protector (Q*M) Overcurrent relay (K*S) Discharge thermal protector (S*T) Low pressure High pressure switch (S*PH) Reverse phase protector (R*P) 	Check on the controller and refer to Symptom 5: One of the following safety devices is activated.
The anti-recycling timer is still active.	The circuit can only start up after approximately 10 minutes.
The guard timer is still active.	The circuit can only start up after approximately 1 minute.
The circuit is limited.	Check the enable/disable capacity limitation remote contact.

Symptom 5: One of the following safety devices is activated

Symptom 5.1: Overcurrent relay of compressor	
POSSIBLE CAUSES	CORRECTIVE ACTION
Failure of one of the phases.	Check fuses on the supply panel or measure the supply voltage.
Voltage too low.	Measure the supply voltage.
Overload of motor.	Reset. If the failure persists, call your local dealer.
RESET	
<i>Push the blue button on the over-current relay inside the switch box and reset the controller.</i>	

Symptom 5.2: Low pressure	
POSSIBLE CAUSES	CORRECTIVE ACTION
Air- or waterflow to heat exchanger too low.	Increase the air- or water flow.
Shortage of refrigerant.	Check for leaks and refill refrigerant, if necessary.
Unit is working out of its operation range.	Check the operation conditions of the unit.
RESET	
<i>After pressure rise, this safety resets automatically, but the controller still needs to be reset.</i>	

Symptom 5.3: High-pressure switch	
POSSIBLE CAUSES	CORRECTIVE ACTION
Condenser fan does not operate properly.	Check that the fans turn freely. Clean if necessary.
Dirty or partially blocked condenser.	Remove any obstacle and clean condenser coil using brush and blower.
Inlet air temperature of the condenser is too high.	The air temperature measured at the inlet of the condenser may not exceed 43°C.
Fan turning in the wrong direction.	Two phases of the power supply to the fan motor must be inverted (by a licensed electrician).
RESET	
<i>After pressure decrease, push the button on the high-pressure switch and reset the controller.</i>	

Symptom 5.4: Fan thermal protector is activated	
POSSIBLE CAUSES	CORRECTIVE ACTION
Mechanical failure (fan is blocked).	Check that the fan rotates freely.
Air flow in the unit too low or outdoor temperature too high.	Clean the air heat exchanger properly.
RESET	
<i>After temperature decrease, the thermal protector is reset automatically.</i>	
<i>If the protector is activated frequently, replace the motor or call your local dealer.</i>	

Symptom 5.5: Reverse phase protector is activated	
POSSIBLE CAUSES	CORRECTIVE ACTION
Two phases of the power supply are connected in the wrong phase position.	Invert two phases of the power supply (by licensed electrician).
One phase is not connected properly.	Check the connection of all phases.
RESET	<i>After inverting two phases or fixing the power supply cables properly, the protector is reset automatically, but the controller still needs to be reset.</i>
Symptom 5.6: Discharge thermal protector is activated	
POSSIBLE CAUSES	CORRECTIVE ACTION
Unit is working outside the operation range.	Check the operation condition of the unit.
RESET	<i>After temperature decrease, the thermal protector resets automatically but the controller still needs to be reset.</i>
Symptom 5.7: Flowswitch is activated	
POSSIBLE CAUSES	CORRECTIVE ACTION
No air- or waterflow over/through the evaporator.	Check the fan- or water pump.
RESET	<i>After finding the cause, the flowswitch is reset automatically, but the controller still needs to be reset.</i>
Symptom 5.8: Compressor thermal protector is activated	
POSSIBLE CAUSES	CORRECTIVE ACTION
Compressor motor coil temperature too high.	Compressor is not cooled sufficiently by the refrigerant medium.
RESET	<i>After temperature decrease the thermal protector is reset automatically, but the circuit controller needs to be reset. If the protector is activated frequently, call your local dealer.</i>

Symptom 6: Unit stops soon after operation

POSSIBLE CAUSES	CORRECTIVE ACTION
The schedule timer is activated and is in off mode.	Work according to the settings in the schedule timer or disable the schedule timer.
One of the safety devices is activated.	Check safety devices (refer to Symptom 5: One of the following safety devices is activated).
Voltage is too low.	Test the voltage in the supply panel and, if necessary, in the electrical compartment of the unit (voltage drop due to supply cables is too high).

Symptom 7: Excessive noises and vibrations of the unit

POSSIBLE CAUSES	CORRECTIVE ACTION
Unit has not been fixed properly.	Fix the unit as described in the installation manual.

Symptom 8: The alarm message shows CONTR. MOTOR ERR

POSSIBLE CAUSES	CORRECTIVE ACTION
The control motor is not reacting due to bad wiring to the motor or the motor is damaged.	Check if the wiring to the control motor is correct and not damaged or loose.

Symptom 9: The alarm message shows CONTR. MOTOR REV

POSSIBLE CAUSES	CORRECTIVE ACTION
The control motor is operating in reverse due to wrong wiring.	Check if the wiring is according to the wiring diagram.

Symptom 10: Sensor or transmitter error

POSSIBLE CAUSES	CORRECTIVE ACTION
The wiring is wrong.	Check if the wiring is according to the wiring diagram. Call your local dealer.

MAINTENANCE

In order to ensure optimal availability of the unit, a number of checks and inspections on the unit and the field wiring have to be carried out at regular intervals.

If the unit is used for air conditioning application, the described checks must be executed at least once a year. In case the unit is used for other applications, the checks must be executed every 4 months.



Before carrying out any maintenance or repair activity, always switch off the circuit breaker on the supply panel, remove the fuses or open the protection devices of the unit.

Never clean the unit with water under pressure.

Maintenance activities



The wiring and power supply must be checked by a licensed electrician.

- **Air heat exchanger**
Remove dust and any other contaminant from the coil fins using a brush and a blower. Blow from the inside of the unit. Take care not to bend or damage the fins.
- **Field wiring and power supply**
 - Check the power supply voltage on the local supply panel. The voltage must correspond to the voltage marked on the identification label of the unit.
 - Check the connections and make sure they are properly fixed.
 - Check the proper operation of the circuit breaker and the earth leak detector provided on the local supply panel.
- **Internal wiring of the unit**
Visually check the switch boxes on loose connections (terminals and components). Make sure that the electrical components are not damaged or loose.
- **Earth connection**
Make sure that the earth wires are still connected properly and that the earth terminals are tightened.
- **Refrigerant circuit**
 - Check for leaks inside the unit. In case a leak is detected, call your local dealer.
 - Check the working pressure of the unit. Refer to "[Switching the unit on](#)" on page 6.
- **Compressor**
 - Check on oil leaks. If there is an oil leak, call your local dealer.
 - Check for abnormal noises and vibrations. If the compressor is damaged, call your local dealer.
- **Fan motor**
 - Clean the cooling ribs of the motor.
 - Check on abnormal noises. If the fan or motor are damaged, call your local dealer.
- **Water sensors**
Check that all the water sensors are correctly fixed into the heat exchanger (see also the sticker attached to the heat exchanger).

Disposal requirements

Dismantling of the unit, treatment of the refrigerant, of oil and of other parts must be done in accordance with relevant local and national legislation.

ANNEX I

Thermostat parameters

Thermostat control

The figure below shows the thermostat diagram.

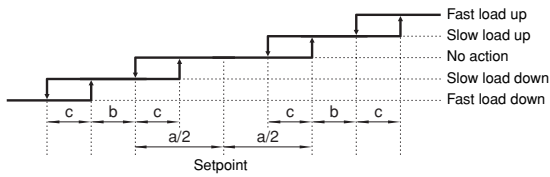

The default value and the upper and lower limits of the thermostat parameters are listed in the table below.

THERMOSTAT		Default value	Lower limit	Upper limit
Step difference - a	(K)	0.8 ^(a)	—	—
Step difference - b	(K)	0.5 ^(a)	—	—
Steplength - c	(K)	0.2 ^(a)	—	—
Loadup timer	(sec)	12	12	300
Loaddown timer	(sec)	12	12	300
Setpoint	(°C)	7.0	4.0	16.0

(a) can only be modified in the service menu

- If the temperature is below the setpoint, the thermostat control will check every LOADDOWN TIMER. According to the deviation to the setpoint, no action, slow load down (=−3%) or fast load down (=−7%) is required.
- If the temperature is above the setpoint, the thermostat control will check every LOADUP TIMER. According to the deviation to the setpoint, no action, slow load up (=+3%) or fast load up (=+7%) is required.

ANNEX II

Schedule timer example

MARCH						
MON	TUE	WED	THU	FRI	SAT	SUN
1 G1	2 G1	3 G2	4 G1	5 G1	6 G3	7 G3
8 G1	9 G1	10 G2	11 G1	12 G1	13 G3	14 G3
15 G1	16 G1	17 G2	18 G1	19 G1	20 G3	21 G3
22 G1	23 H	24 H	25 H	26 H	27 H	28 H
29 H	30 G1	31 G2				

To come to the schedule above following settings have to be made:

```

_+ SCHEDULE TIMER
MON:G1 THU:G1 SAT:G3
TUE:G1 FRI:G1 SUN:G3
WED:G2

```

⋮

```

_+HD PERIOD:01 TO 03
01:23/03 TO 29/03
02:00/00 TO 00/00
03:00/00 TO 00/00

```

All days assigned to the same group will work according to the settings of this group.

In this example setting:

- all Mondays, Tuesdays, Thursdays and Fridays will work according to the settings in group 1 (G1),
- all Wednesdays will work according to the settings in group 2 (G2),
- all Saturdays and Sundays will work according to the settings in group 3 (G3),
- all holiday days will work according to the settings in the holiday group (H).

All group settings of groups G1, G2, G3, G4 and H work similar as following example (settings for group 1):

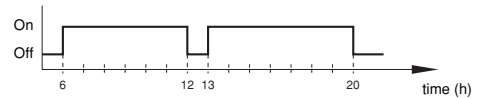

```

_+ GROUP1:01 TO 03
1:00h00
2:06h00 ON 00.0
3:00h00

```

Screen 1

⋮

```

_+ GROUP1:04 TO 06
4:12h00 OFF 00.0
5:13h00 ON 00.0
6:20h00 OFF 00.0

```

Screen 2

ANNEX III

Floating setpoint working

The diagram and table below show the default value and the upper and lower limits of the floating setpoint parameters on the evaporator.

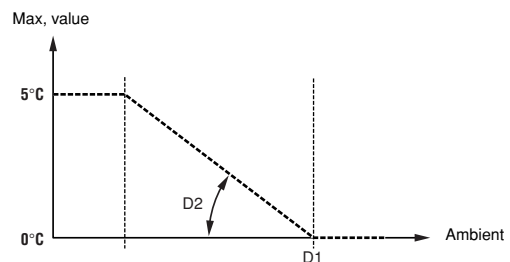

Floating setpoint		Default value	Lower limit	Upper limit
Maximum value	(°C)	3.0	0.0	5.0
D1	(°C)	20.0	20.0	43.0
D2 ^(a)	(°C)	5.0	0.0	10.0

(a) rise in floating setpoint value for 10°C drop in ambient

ANNEX IV

